

LEISTER®

English

VARIMAT 700/500/300



Leister Technologies AG

Galileo-Strasse 10

6056 Kaegiswil

Switzerland

+41 41 662 74 74

leister@leister.com

leister.com

Table of Contents

1. Application	4
1.1 Intended use	4
1.2 Non-intended use	4
1.3 General safety information	5
2. Technical data	6
3. Transport	7
4. Your VARIMAT 700/500/300	8
4.1 Type plate and identification	8
4.2 Scope of delivery (standard equipment in the case)	8
4.3 Overview of device parts	9
5. Settings on the VARIMAT 700/500/300	11
5.1 Adjusting the welding nozzles	11
5.2 Additional weights for increasing the contact pressure weight	12
5.3 Adjusting the guide bar	12
5.4 Adjusting the movable transportation axle	13
5.5 Adjusting the track setting	13
6. VARIMAT 700/500/300 commissioning	14
6.1 Work environment and safety	14
6.2 Operating readiness	18
6.3 Starting the device	19
6.4 Welding sequence	19
6.5 Finishing welding	20
6.6 Switching off the device/Maintenance	20
7. VARIMAT 700/500 quick guide	21
7.1 Switching on/Starting	21
7.2 Switching off	21
8. VARIMAT 700/500 control panel	22
8.1 Function buttons	22
8.2 Digital display	23
8.3 Setting the welding parameters	23
8.4 Display symbols of the status display (Display 40)	24
8.5 Display symbols of the work display (Display 41)	25
9. Settings and functions of the VARIMAT 700/500 software	26
9.1 VARIMAT 700/500 menu navigation overview	26
9.2 Basic setting	27
9.3 Formulas	27
9.4 Displaying set values	28
9.5 Eco mode	29
9.6 LQS data recording settings (VARIMAT 700)	29

9.7	Advanced mode settings	33
9.8	WLAN settings	33
9.9	Device settings	33
9.10	Info mode	35
9.11	Duty info	36
9.12	General Info	36
10. VARIMAT 700/500 warning and error messages		37
11. VARIMAT 700/500 FAQs, causes and measures		39
12. Operating VARIMAT 300		41
12.1	Starting the device	41
12.2	Welding sequence	42
12.3	Finishing welding	42
12.4	Switching off the device/Maintenance	42
13. VARIMAT 300 quick guide		43
13.1	Switching on/Starting	43
13.2	Switching off	43
14. VARIMAT 300 operating unit		44
14.1	Function buttons	44
14.2	Digital display	45
14.3	Display symbols of the status display (Display 34)	45
14.4	Display symbols for the welding speed (Display 35)	46
14.5	Display symbols for the welding temperature (Display 36)	46
14.6	Display symbols for the air volume (Display 37)	46
14.7	Status LED display	46
15. Settings and functions of the VARIMAT 300 software		47
15.1	Setting the parameter units	47
15.2	Setting the welding parameters	47
15.3	Cool-down mode	48
15.4	Monitoring welding parameters during runtime	48
16. VARIMAT 300 warning and error messages		49
17. Frequently asked questions, causes and actions VARIMAT 300		50
18. Accessories		52
19. Service and repair		52
20. Training		52
21. Declaration of Conformity		53
22. Disposal		53

Congratulations on your purchase of the VARIMAT 700/500/300.

You have chosen a first-class hot-air welder.

It was developed and produced in accordance with the latest state-of-the-art technology in the plastics-processing sealing sheet industry. It has also been manufactured using high-quality materials.



Please always store these operating instructions with the device.

VARIMAT 700/500/300 Hot-air welder

You can find more information on the VARIMAT 700/500/300 at leister.com



1. Application

1.1 Intended use

The VARIMAT 700/500/300 automatic hot-air welder is designed for professional use on flat roofs.

Welding procedures and types of materials

- Overlap welding of thermoplastic sealing sheets/elastomer sealing sheets (such as TPO, PVC, ECB, modified EPDM, EVA, FPO, PIB, PMI, PO, PP)
- Near-edge welding on the verge (roof parapets and eaves) up to 100 mm.

The legal provisions on health protection applicable in the respective country must be observed. Never use the hot-air welder in explosive or readily inflammable surroundings. Maintain sufficient distance from combustible materials or explosive gases at all times. Read the material safety data sheet from the manufacturer of the material and follow that company's instructions. Be careful not to burn the material during the welding process. Observe  general safety instructions [1.3].

1.2 Non-intended use

Any other use or any use beyond the type of use described is deemed non-intended use.

1.3 General safety information

Please observe the safety instructions provided in the individual chapters of these operating instructions as well as the following safety instructions.

Warning



Risk of death from electric shock due to dangerous electrical voltage

- The device is only to be connected to sockets and extension cables with a protective earth conductor.
- Protect the device from moisture and wet conditions.
- When used on a construction site, a residual current circuit breaker is mandatory.
- Prior to using the device for the first time, check the power cord, the plug, and the extension cable for electrical and mechanical damage.
- The device may only be opened by instructed, qualified personnel.



Danger of fire and explosion with improper use in the vicinity of flammable materials and explosive gases.

- Avoid overheating of the material.
- Never place the device near combustible materials and/or explosive gases.
- Never place the device close to combustible materials and/or explosive gases while it is running and/or hot.
- Only use the device on fireproof surfaces.



Risk of burns due to hot equipment parts and hot air jet

- Do not touch the heating tube and nozzle when they are hot.
- Always allow the device to cool down first.
- Never point the hot air flow at people or animals.

Caution



- The local supply **voltage** must match the nominal **voltage** specified on the device.
- Maximum network impedance according to EN 61000-3-11 / UL 499 / CSA C22.2 No 88: $Z_{max} = 0.169 \Omega + j 0.106 \Omega$. In case of doubt, the responsible electricity supply company should be contacted.
- If the power supply fails, switch off the unit at the main switch and swing the hot air blower into the park position, in order to avoid damage to the hot-air blower.











- Only operate the device **under supervision** as waste heat can reach flammable materials.
- The device should only be operated by **trained specialists** or under their supervision.
- Children are not permitted to operate the device.



Risk of glare due to the LED light beam

- Avoid direct eye contact with the LED light beam.

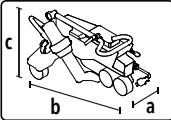
2. Technical data

			VARIMAT 700 230V	VARIMAT 700 400V	VARIMAT 500 230V	VARIMAT 500 400V	VARIMAT 300 230V	VARIMAT 300 400V	
	Voltage	V~	230	400	230	400	230	400	
	Capacity	W	3680	5700	3680	5700	3680	5700	
	Frequency	Hz	50/60						
	Temperature	°C	100-620						
	Max. Ambient temperature	°C	65						
		°F	149						
	Air volume	%	45-100						
	Drive	m/min ft/min	1.0-12				1.0-10		
			3.2-39.4				3.2-32.8		
	Noise level	L _{PA} (dB)	70 (K = 3 dB)						
Wi-Fi radio characteristic									
	RF frequency range	GHz	2.400 - 2.4835				--		
	Transmit power 802.11 g	dBm	15 ± 1				--		
	Weight	kg	37.5						
		lbs	83.0						
Dimensions 		a) mm	337						
		inch	13.3						
		b) mm	605						
		inch	23.8						
		c) mm	343						
		inch	13.5						
 									

We reserve the right to make technical changes.

3. Transport



- Comply with applicable national regulations regarding the carrying or lifting of loads.
- For transporting the hot-air welder use the transport box included in the scope of delivery and carry the transport box using the handle provided for the purpose.
- The weight of your VARIMAT 700/500/300, including the transport box, is 45.0 kg (37.5 kg without transport box, including 1 weight).



- **Two persons are required** for transporting the machine with the transport box.



Fire hazard when transporting while hot

- The **hot air blower (9)** reaches temperatures of 620 °C.
- Allow the **hot-air blower (9)** to cool down sufficiently prior to transport (see  Cool Down mode [15.3]).
- Never store flammable materials (such as plastic or wood) in the transport box.



- Never use the **carrying handle (4)** on the device or on the transport box for transporting with a crane, as this may cause the unit to fall.



- Never lift the hot-air welding machine by the **auxiliary weights (3)** as there is a risk of the machine falling.



To lift up the hot air welder by hand, use the **carrying handle (4)**.

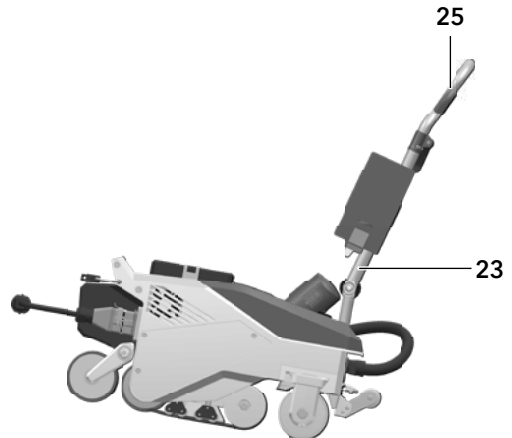

To position the hot air welder, press the **guide bar (23, 25)** and then roll the device in this way into the desired welding position.

4. Your VARIMAT 700/500/300

4.1 Type plate and identification

The model and serial number are indicated on your device's **name plate (18)**.

Transfer this information to your operating instructions; in the event of any inquiries to our country subsidiary or your authorized Leister sales and service partner, please always refer to this information.

Model:

Serial no.:

Example:



4.2 Scope of delivery (standard equipment in the case)

1 VARIMAT 700/500/300 device

1 auxiliary weight

Guide bar, folded in

Upper handle

5 m cable

1 wire brush

2 welding protection plates

1 nozzle adjustment gauge

1 Torx T20 screwdriver length 250 mm

1 safety Instructions

1 Quick Reference Guide

1 hexagonal pin spanner, size 4

4.3 Overview of device parts

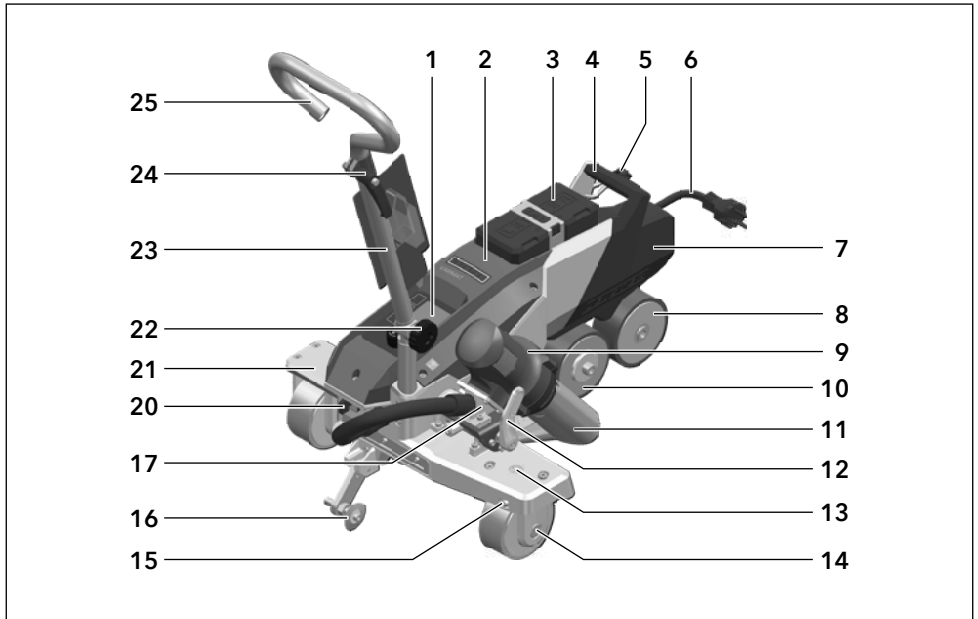

- | | |
|---|--|
| 1. Control panel | 16. Track guide roller |
| 2. Housing | 17. Swivel mechanism |
| 3. Auxiliary weight | 18. Type plate with model designation and series marking |
| 4. Carrying handle | 19. Activating sliding transport axis |
| 5. Holder for power cord (with carabiner for hanging) | 20. Main switch (On/Off switch) |
| 6. Power cord | 21. Movable transport axis |
| 7. Basic weight | 22. Locking screw (guide bar) |
| 8. Trailing roller | 23. Guide bar, bottom |
| 9. Hot Air Blowers | 24. Clamping lever, guide bar, top part |
| 10. Drive roller / contact pressure roller | 25. Guide bar, top |
| 11. 40 mm welding nozzle | 26. Press-down belt |
| 12. Hot-air blower lock | 27. Deflection roller |
| 13. Track setting display | |
| 14. Transport roller | |
| 15. Track setting | |

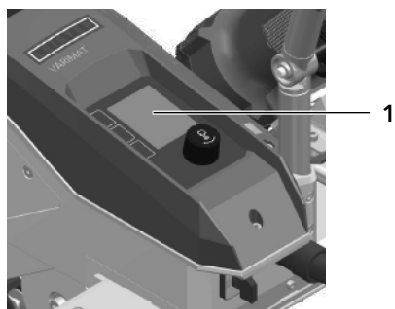

Control panel (1) VARIMAT 700/500

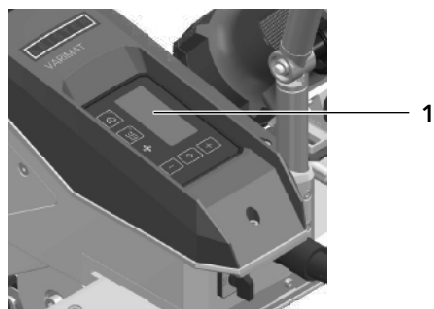

Control panel (1) VARIMAT 300

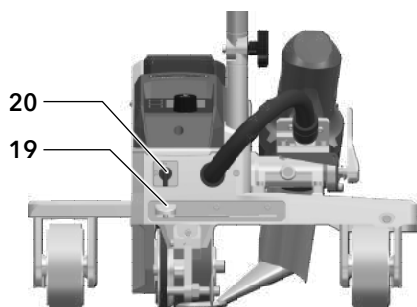

Actuation of movable transport axis (19), main switch (20)

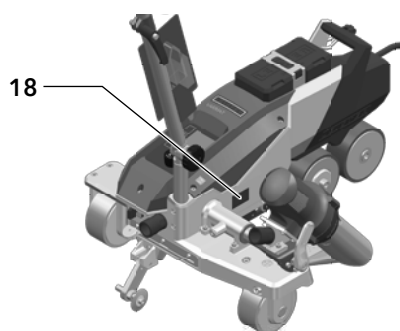

Type plate (18)

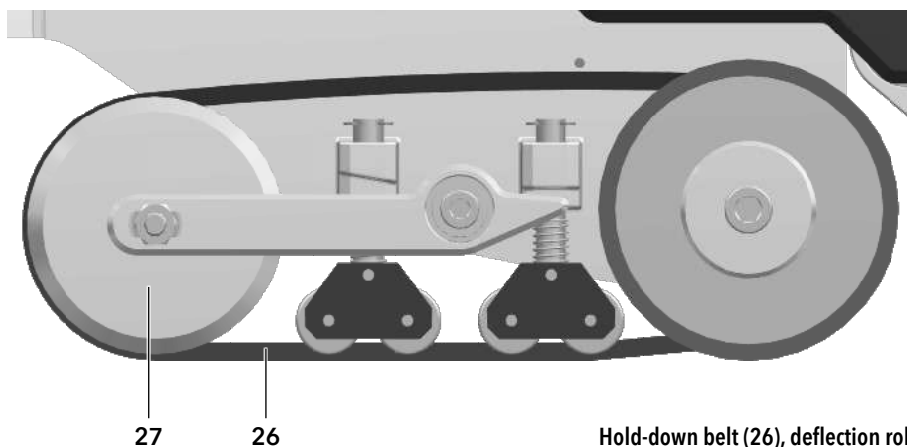

Hold-down belt (26), deflection roller (27)

5. Settings on the VARIMAT 700/500/300

5.1 Adjusting the welding nozzles

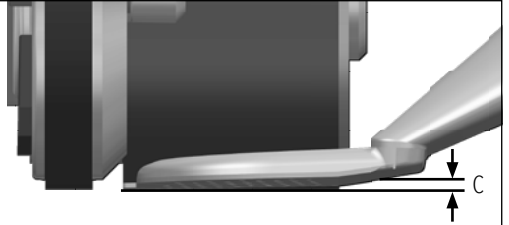
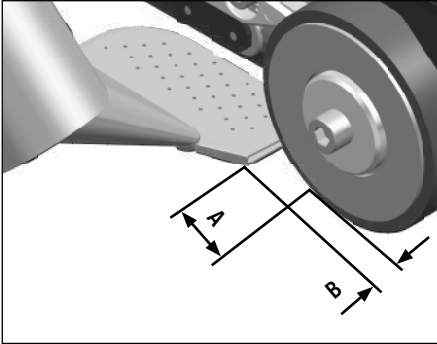

- A = 55 mm +/- 2
- B = 1-2 mm
- C = 1 mm

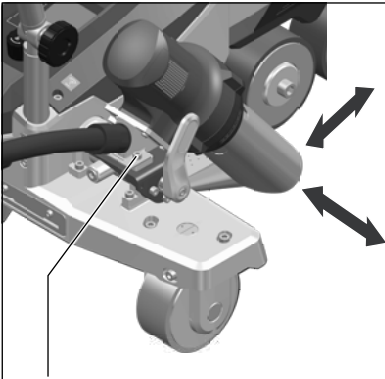

2 x socket head screws

Set dimension „A + B“ (2 socket head screws)
Set dimension „C“ (4 Torx screws)

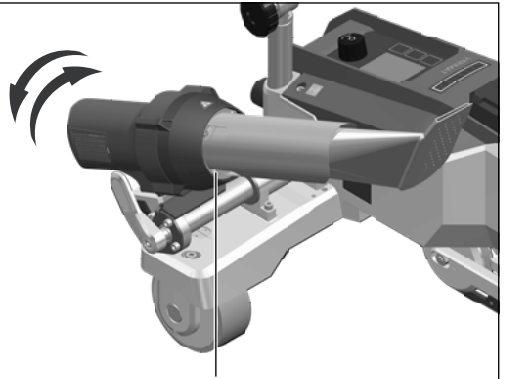

4 x Torx screws

5.2 Additional weights for increasing the contact pressure weight

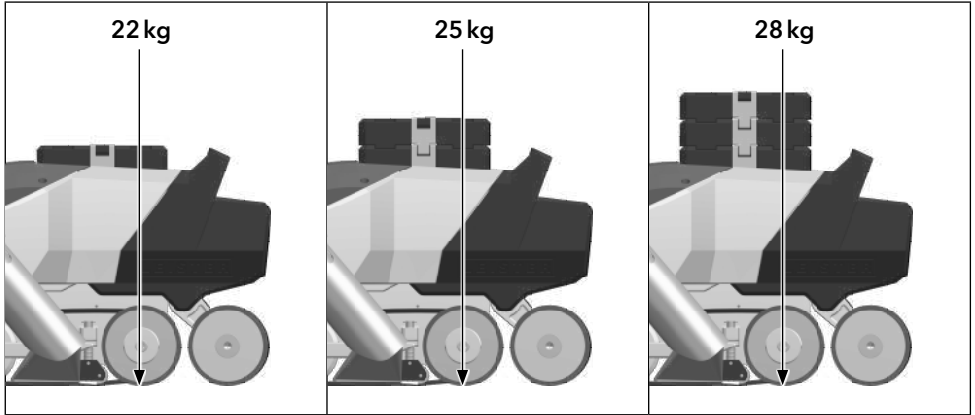

The **base weight (7)** weighs 13.5 kg and can be removed for transportation.

5.3 Adjusting the guide bar

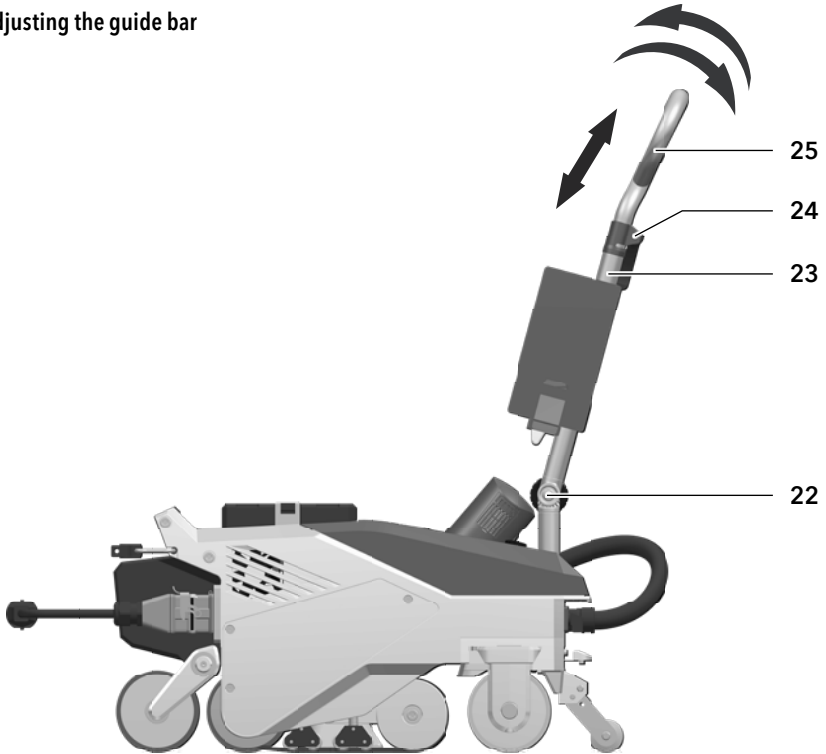

5.4 Adjusting the movable transportation axle

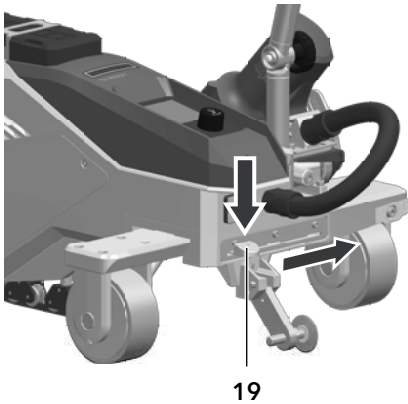

- Position 1:** End position Basic welds Welding
Position 2: Middle position Basic welds Welding
Position 3: Welding close to the edge

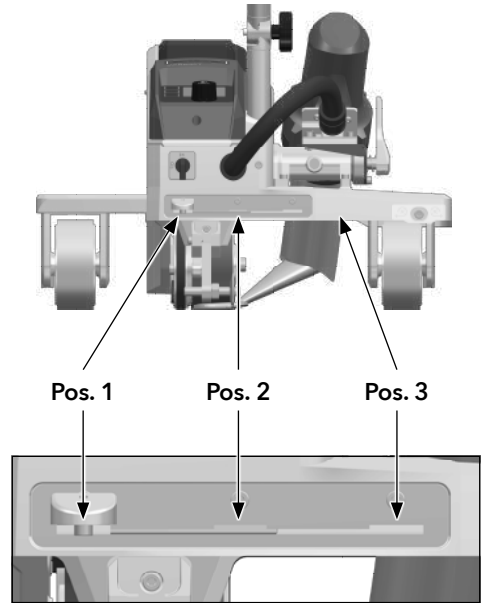

5.5 Adjusting the track setting

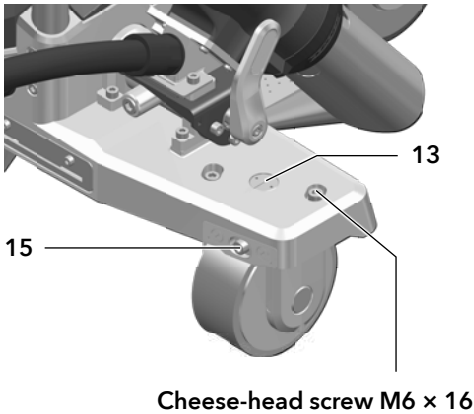

1. Undo the two M6 x 16 cheese-head screws.
2. Set the track with the **track setting (15)**.



3. Check the setting on the **track setting indicator (13)**.
4. Retighten the two M6 x 16 cheese-head screws.

6. VARIMAT 700/500/300 commissioning

6.1 Work environment and safety

Safety precautions



Risk of death from electric shock due to dangerous electrical voltage

- The device is only to be connected to sockets and extension cables with a protective earth conductor.
- Protect the device from moisture and wet conditions.
- When used on a construction site, a residual current circuit breaker is mandatory.
- Prior to using the device for the first time, check the power cord, the plug, and the extension cable for electrical and mechanical damage.
- The device may only be opened by instructed, qualified personnel.



Danger of fire and explosion with improper use in the vicinity of flammable materials and explosive gases.

- Avoid overheating of the material.
- Never place the device near combustible materials and/or explosive gases.
- Never place the device close to combustible materials and/or explosive gases while it is running and/or hot.
- Only use the device on fireproof surfaces.



Risk of burns due to hot equipment parts and hot air jet

- Do not touch the heating tube and nozzle when they are hot.
- Always allow the device to cool down first.
- Never point the hot air flow at people or animals.



Risk of inadvertently becoming caught and being pulled in due to moving parts

- Do not touch any moving parts.
- Do not wear loose articles of clothing such as scarves or shawls.
- Tie up long hair and protect it with a head covering.



Health risk due to harmful fumes

- Welding PVC materials creates harmful hydrogen chloride vapors.
- Always ensure good ventilation of the workplace when working.
- Read the material safety data sheet from the manufacturer of the material and follow that company's instructions.
- Be careful not to burn the material during the welding process.



Risk of tripping due to power cord

- The **power cord (6)** must be able to move freely and must not hinder the user or third parties during work (trip hazard).



- The local supply **voltage** must match the nominal **voltage** specified on the device.
- Maximum network impedance according to EN 61000-3-11 / UL 499 / CSA C22.2 No 88: $Z_{max} = 0.169 \Omega + j 0.106 \Omega$. In case of doubt, the responsible electricity supply company should be contacted.
- If the power supply fails, switch off the unit at the main switch and swing the hot air blower into the park position, in order to avoid damage to the hot-air blower.



Caution

- Comply with national statutory requirements regarding occupational safety (securing personnel or devices).



Risk of glare due to the LED light beam

- Avoid direct eye contact with the LED light beam.



Caution

- Only use the device on horizontal and fireproof surfaces.



- Comply with applicable national regulations regarding the carrying or lifting of loads.
- For transporting the hot-air welder use the transport box included in the scope of delivery and carry the transport box using the handle provided for the purpose.
- The weight of your VARIMAT 700/500/300, including the transport box, is 45.0 kg (37.5 kg without transport box, including 1 weight).



- **Two persons are required** for transporting the machine with the transport box.



- **Anti-fall protection when working in areas where there is a fall hazard**
- **When welding on roof parapets (parapet, eaves), the hot air welder on the carrying handle (4) must be secured to a stop fixture with horizontal guides (such as rail or rope safety systems) as protection against falling.**
- With respect to the safety chain, care must be taken to ensure that all of the safety elements (carabiner hooks, ropes) have a minimum load-carrying capacity of 7 kN in every direction that can be anticipated. It is mandatory to use locking carabiners (twist-lock or screw types) to hook the unit. You must properly install and check all connections of the safety chain according to the manufacturer's specifications.

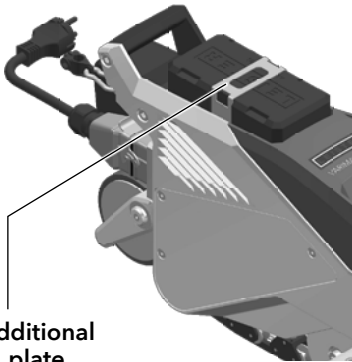
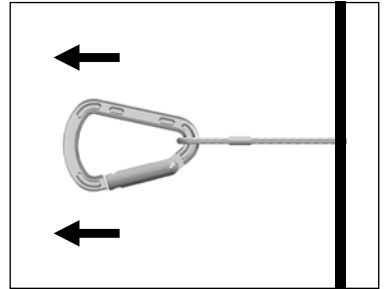
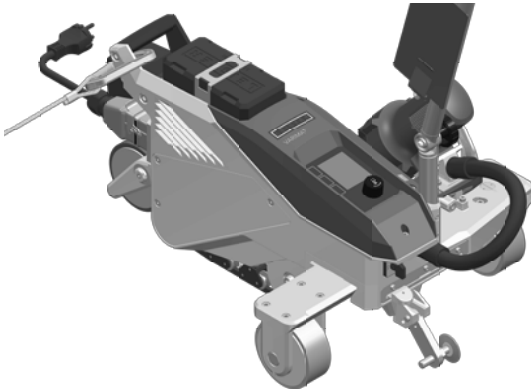

Additional plate

Before each use and after unusual occurrences, the **carrying handle (4)** that is used for fastening the safety rope must be inspected by an individual with expertise in this area. The **carrying handle (4)** is not permitted to exhibit any cracks, corrosion, notches or other material faults.

Secure the additional weights with the additional plates provided (1 per weight).



Caution

- Only secure the hot air welding machine by the **carrying handle (4)**.
- Never fasten the hot wedge welding machine to single anchoring points which allow ropes to sag. Always set the connection equipment to the shortest length possible in order to eliminate any chance of falling over the edge of the parapet.

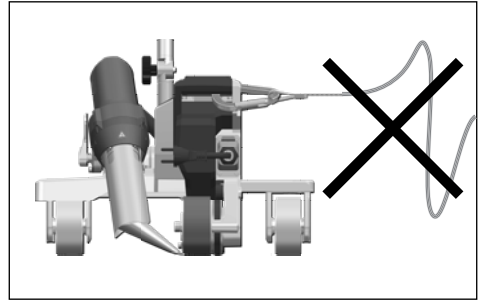
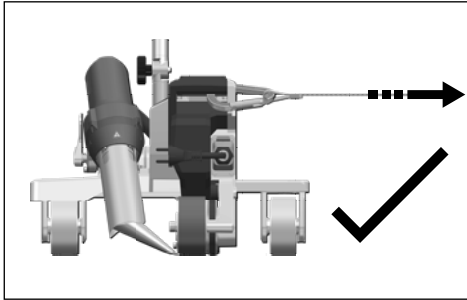

Caution

- The device may fall or drop in an uncontrolled manner due to gravity. The securing point is not designed to withstand the shock-like stress of an abrupt fall.
- Please do not hesitate to contact the manufacturer if anything is unclear during installation or operation.

Power cord and extension cable



- The nominal voltage specified on the device (see  Technical data [2]) must match the supply voltage.
- The **power cord (6)** must be able to move freely and must not hinder the user or third parties during work (trip hazard).
- The extension cables must be authorized for the utilization site (e.g., outdoors) and be marked accordingly. Take the necessary minimum cross-section for extension cables into account as required.

On-site generators for power supply

When using on-site generators as a power supply, please ensure that the on-site generators are grounded and equipped with residual-current circuit breakers.

For the nominal output of the power plants, the formula „1.5-2 × nominal output of the hot-air welder“ applies.

6.2 Operating readiness

Hang the strain relief of the **power supply cord (6)** from the **power cord holder (5)** and then check the basic setting of the **welding nozzle (11)**.

See the how-to videos on [Leister's YouTube channel](#)

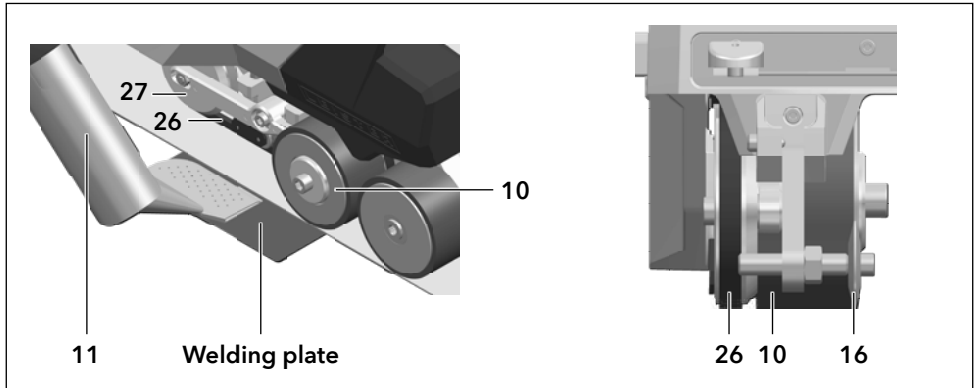

6.3 Starting the device

- Once you have prepared the working area and the hot air welder in accordance with the instructions, connect the hot air welder to the supply voltage.
- Use the **main switch (20)** to switch the hot-air welder on.



After startup, the **Start screen** will appear briefly in the display, with the version number of the current software release and the device designation.

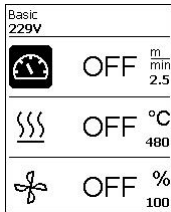

If the device was allowed to cool down beforehand, this will be followed by a static display of the set values of the most recently used profile (the Basic profile is displayed when the device is first commissioned).

The heating is not yet switched on at this stage.

- Select the desired welding profile or define the welding parameters individually.
- Now switch the heating on with the *heating On/Off button (31)*.

6.4 Welding sequence

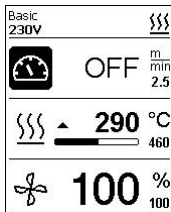

Preparing for welding

As soon as you have switched on the heating, you will see a **dynamic display of the current air temperature with a progress bar** (actual and set values).

- Make sure that the welding temperature has been reached before commencing work (the heating-up time is 3 – 5 minutes).
- Now carry out test welds in accordance with the welding instructions of the material manufacturer and/or national standards or regulations and inspect the results. Adjust the welding profile as required.

Start welding

- Press the **hot-air blower lock lever (12)**, lower the **hot-air blower (9)** and guide the **welding nozzle (11)** between the overlapping sheets up to the stop.
- The drive motor starts automatically as soon as the **hot-air blower (9)** is engaged.
- You can also start the device manually with the *Drive On/Off button (30)*.
- Guide the hot-air welder by the **guide bar (23, 25)** or by the **carrying handle (4)** along the overlap and also observe the position of the **track guide roller (16)**.
- Avoid applying pressure to the **guide bar (23, 25)** during the welding process, as doing so could lead to welding faults.

6.5 Finishing welding

- After finishing welding, press the **hot-air blower lock lever (12)**, extend the **hot-air blower (9)** up to the stop (this stops the drive motor) and swivel it upwards until it engages.
- Then swivel the **track guide roller (16)** upwards.

6.6 Switching off the device/Maintenance

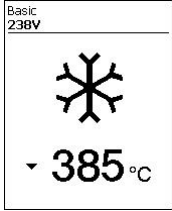

Use the *Heating On/Off button (31)* to switch off the heating, so the **welding nozzle (11)** cools down.

This will trigger the cool-down mode.

- The blower switches off automatically after approx. 6 minutes.
- Now switch off the device with the **main switch (20)** and disconnect the **power cord (6)** from the electrical network.



- Wait until the device has cooled down.
- Check the **power cord (6)** and plug for electrical and/or mechanical damage.
- Use a wire brush to clean the **welding nozzle (11)**.

7. VARIMAT 700/500 quick guide



Observe the safety instructions and warnings in the individual sections of these operating instructions.

7.1 Switching on/Starting

1. Make sure that the **main switch (20)** is switched off and the **hot-air blowers (9)** are in parking position. Connect the plug to the mains voltage.
2. Switch the **main switch (20)** on.
3. Switch on the heating with the *heating On/Off (31)* button; wait 3–5 minutes until the desired temperature is reached.
4. Swivel the **hot-air blower (9)** downwards (appliance starts automatically).

7.2 Switching off

1. Swivel the **hot-air blower (9)** upwards (stops the drive motor).
2. Use the **Heating on/off button (31)** to switch off the heating.
3. Wait for the end of the **cooling process** (approx. 6 minutes).
4. Switch off the unit at the **main switch (20)**.
5. Disconnect the **plug** from the mains voltage.

**VARIMAT 700 / 500 / 300**
Quick Guide

 Operating Instructions:
leister.link/qg-dlp-varimat-700



 Download
myLeister App



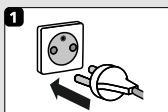

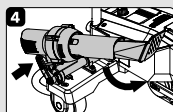

**1** 

2  ON

3 

4 

**1** 
230V/400V

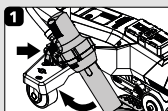

**3** 
5 min

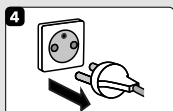

**1** 

2 

3  OFF

4 

**2** 

**4** 

QG VARIMAT 700/500/300 / 12.2023 / 175.792

8. VARIMAT 700/500 control panel



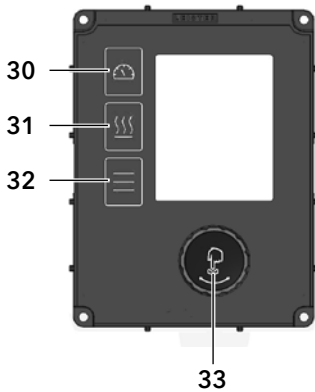

The **control panel (1)** is comprised of the **function buttons** with which you control the various menu functions, and the **display** where the respectively selected setting, menu options or the values valid for the running time are displayed.

8.1 Function buttons



- 30. Button *Drive On/Off*
- 31. Button *Heating On/Off*
- 32. Button *Menu*
- 33. *e-Drive*

Multiple allocation of function buttons Control panel (1)

Symbol	Name	In the work display (41)	In the menu, after pressing the button (32)
	Button <i>Drive On/Off</i> (30)		Selection of line when editing text
	Button <i>Heating On/Off</i> (31)		Selection of line when editing text
	Button <i>Menu</i> (31)	Switch to menu	Return to the working display
	<i>e-Drive</i> (33) press	Selected value is adopted, selection goes straight back to the function display	Selects the marked position
	<i>e-Drive</i> (33) rotate	Sets the required set value in 0.1 m/min, 10 °C or 5 % steps	Changes the position within the setup menu and sets the value of the selected position

8.2 Digital display

The display is subdivided into two display areas:

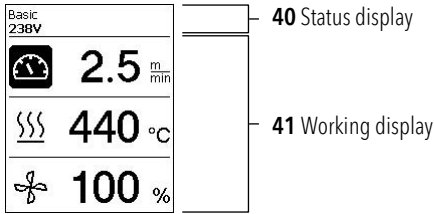

8.3 Setting the welding parameters

To adjust a welding parameter before welding, proceed as follows:

Example for setting the welding temperature

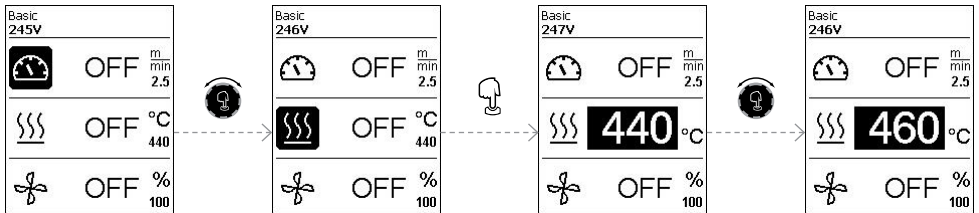

If you do not make any more entries, the cursor automatically jumps back to the temperature symbol. You can then select the next welding parameter with the *e-Drive* button (33).

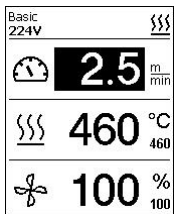

During the welding process, the cursor is always on the Drive icon. **You can adjust the welding speed at any time using the *e-Drive* button (33).**

If you want to adjust another parameter, first press the *e-Drive* button (33), then turn the *e-Drive* button (33) and select the desired parameter.

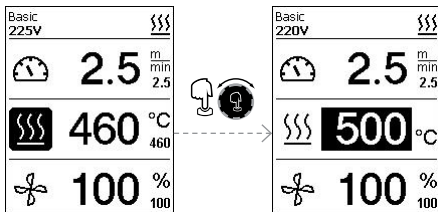

If you do not make any further entries, the cursor automatically jumps back to the Drive icon if the Info Mode is not switched on.

8.4 Display symbols of the status display (Display 40)

The Status display is subdivided into a left-hand (1) and a right-hand area (2).

Status display 1/Left	
Profile name	Displays the name of the selected, currently valid welding profile (such as Basic). If a profile name contains more than 6 characters, the first 6 characters are shown first, followed by the remaining 6 characters. The system then presents the first 6 characters.
Voltage	Display of the supply voltage
Status display 2/Right	



Warning present



Data recording



Overvoltage



Eco mode



GPS data reception



Undervoltage



WLAN



Stop Device on Alert
switched on



Heating





Application protection
switched on













Application protection
active

8.5 Display symbols of the work display (Display 41)

	2.5 ^m / _{min}
	440 °C
	100 %

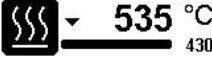
During operation, the set values of the welding parameters (drive in m/min or ft/min, temperature in degrees Celsius (°C) or Fahrenheit (°F), air volume in percent (%) and, if applicable, information notes (see  Info Mode [9.10]) are displayed.

You can use the *e-Drive* button (33) to switch between the welding parameters. By pressing the *e-Drive* button (33), you select the respective parameter and then adjust it individually by turning the *e-Drive* button (33).

	Symbol drive/welding speed [m/min or ft/min]
	Symbol air temperature [°C or °F]
	Symbol air volume [%]
	Symbol auxiliary weight [N] (available as an option)
	Symbol test weld
	Welding temperature too low, heating process up arrow and progress bar show that the desired higher temperature has not yet been achieved. The flashing number above the progress bar designates the currently achieved actual value (290); the value near the right of the bar (460) shows the set value of the selected welding profile or of the individual setting.
	Welding temperature too high, cooling process down arrow and progress bar show that the desired lower temperature has not yet been achieved. The flashing value above the bar designates the currently achieved actual value (535); the value near the right of the bar (430) shows the set value of the selected welding profile or of the individual setting.
	Symbol for cool-down mode
	Symbol for hardware error warning The device is no longer ready for operation. Please contact your authorized Leister sales and service partner. Note the respective error code in Section Warning and Error Messages.
	Symbol for hardware error warning (heating element is defective). The device is no longer ready for operation. Please contact your authorized Leister sales and service partner.
	Symbol for excessive temperature warning . Allow the device to cool down.

9. Settings and functions of the VARIMAT 700/500 software

Sections 9-10 apply exclusively to the VARIMAT 700 and the VARIMAT 500. Operation of the VARIMAT 300 is dealt with in section 12.

9.1 VARIMAT 700/500 menu navigation overview

Note: Pressing the *Menu* button (32)  will return you to the working display in each menu item.

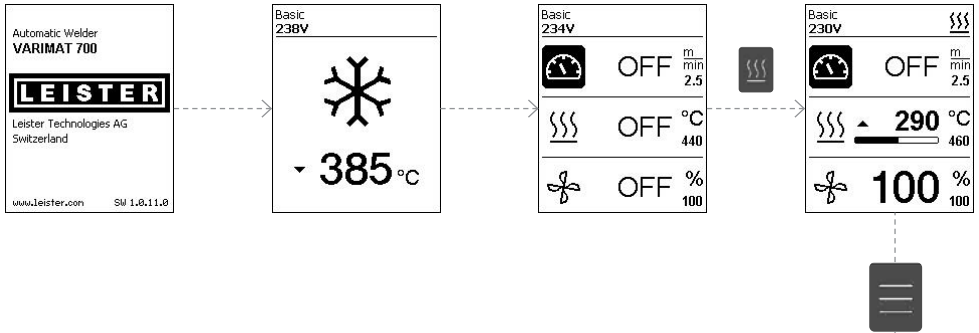

Example: Selection of recipes

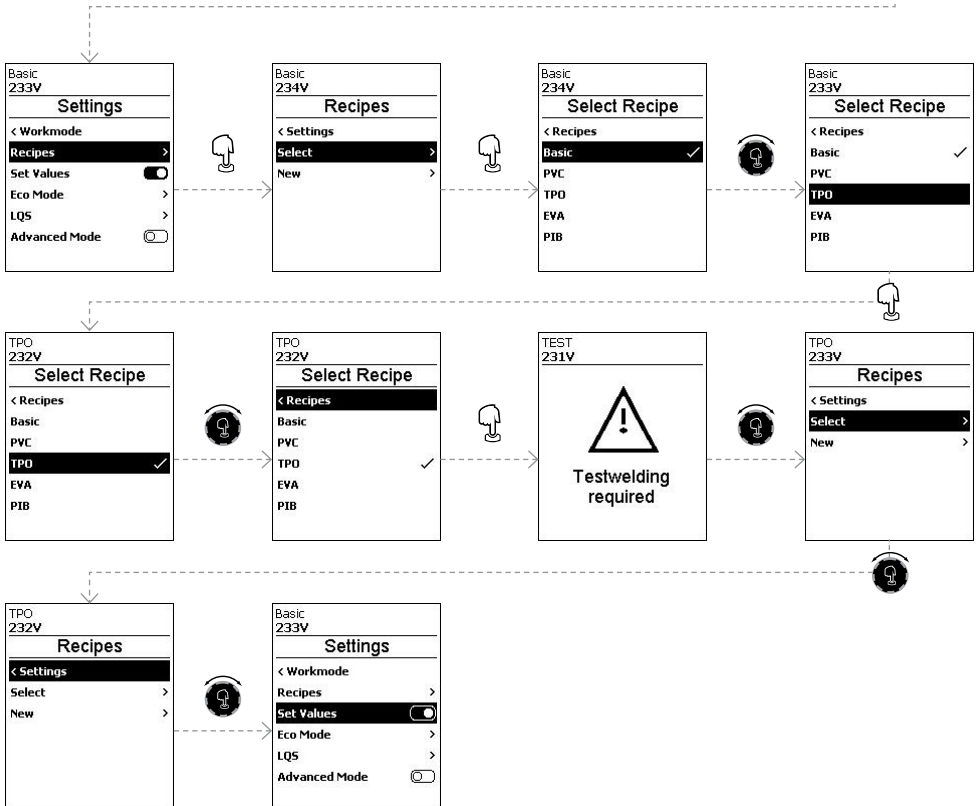

9.2 Basic setting

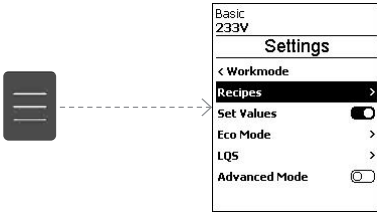

- Formulas
- Display of set values
- Eco mode
- LOS (VARIMAT 700)
- Advanced mode

9.3 Formulas

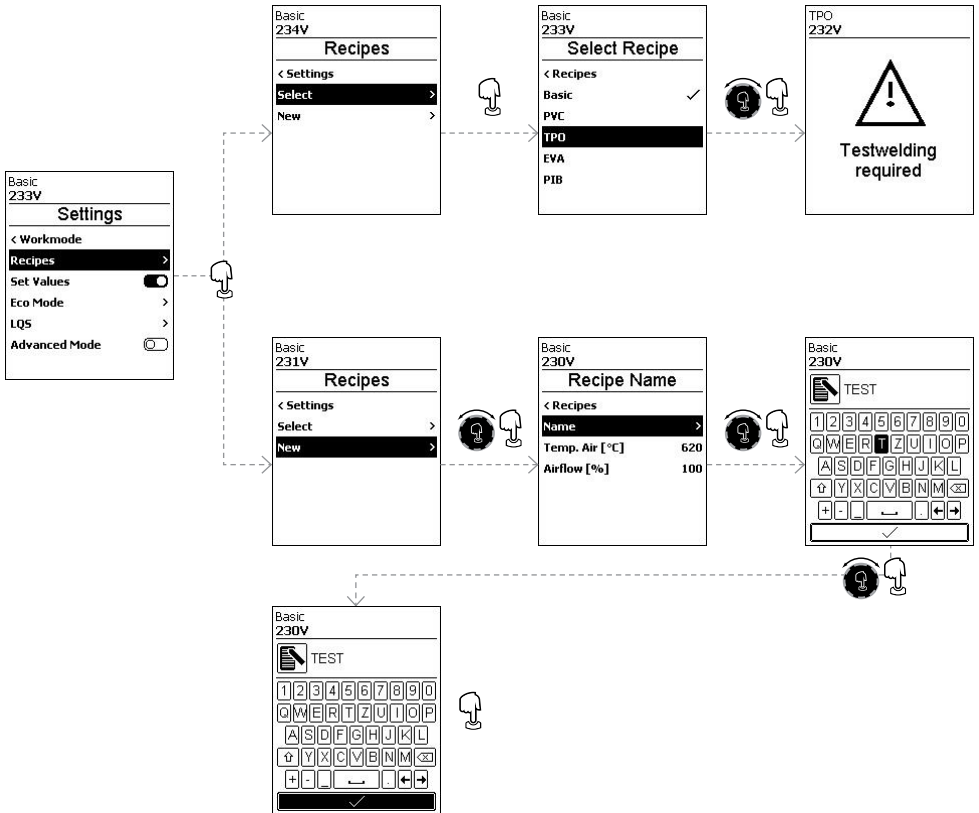

You can adjust the parameters of your own recipes at any time.
 All customizable recipes are displayed.

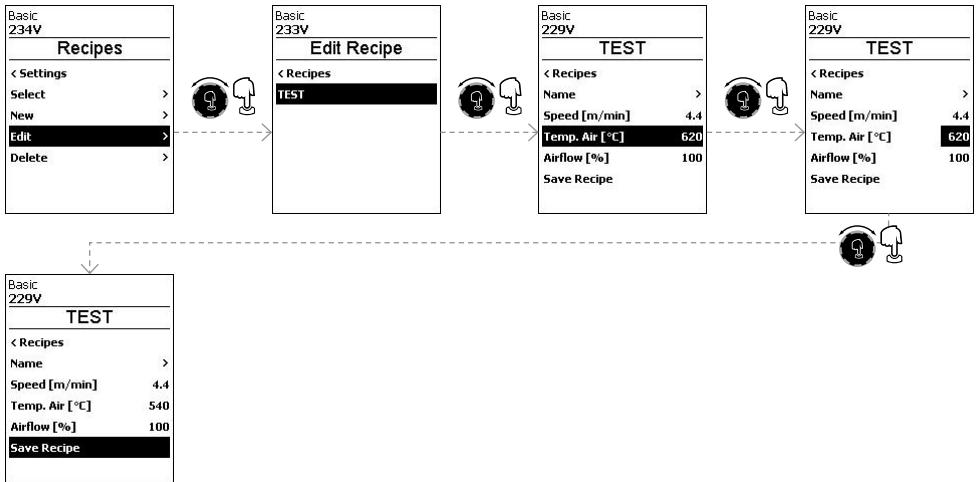

9.4 Displaying set values

The actual value and set value display is switched on in the working display (41) at the factory.
 If you do not wish to display the set value and actual value on the working display (41), you can deactivate Set Values.



If the Set Values function is activated, the actual temperature (high) and the target temperature (low) are shown in the work display (41).



This applies analogously for drive (m/min) or air volume (percent).

9.5 Eco mode

The Eco-Mode function is switched off at the factory. You can activate Eco-Mode by pressing the *e-Drive* button (33).

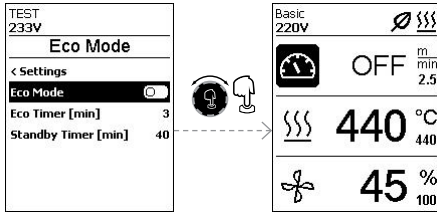

If you have activated Eco-Mode and the device remains inactive for the set period of time, you will automatically switch to Standby Timer mode. The air volume is automatically reduced to 45%. In the working display (41), the Standby Timer is displayed with the corresponding symbol.

After the Standby Timer has expired without activity, the cooling process is automatically initiated. You can interrupt the cooling process with the *Heating On/Off* button (31).

9.6 LQS data recording settings (VARIMAT 700)

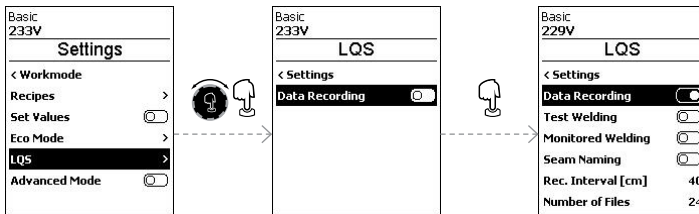

Test Welding

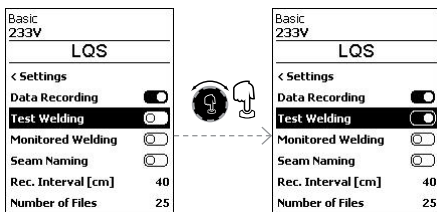

If Test Welding is switched on, you can make a test weld before the actual welding process.

Monitored Welding

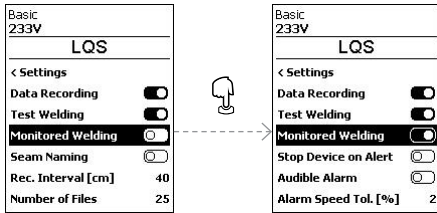

If Monitored Welding is switched on, limit values of the recorded welding parameters are logged.

Stop Device on Alert

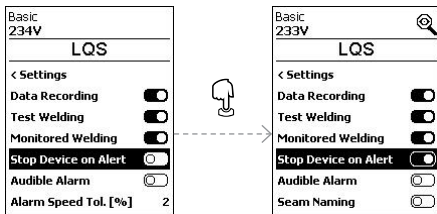

If Stop Device on Alert is switched on, the heating and drive are switched off if the limit value is exceeded. The limit values are specified. The maximum permissible temperature deviation of the hot-air blower is 10 °C; the permissible deviation of the drive speed is 4 % and the deviation of the fan speed is 5 %.

If the limit value is exceeded, the machine stops automatically after 30 seconds. The Stop Device on Alert symbol is displayed in the status display (40).

Audible Alarm

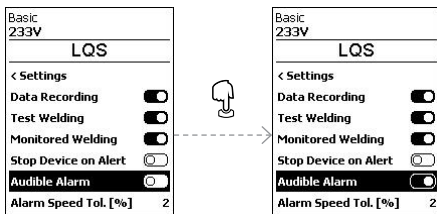

If the Audible Alarm is switched on, an acoustic alarm sounds when the limit value is exceeded.

If **Stop Device on Alert** is not activated, you can set the limit deviations for drive speed (Speed), hot air fan temperature (Heat) and fan speed (Air) individually.

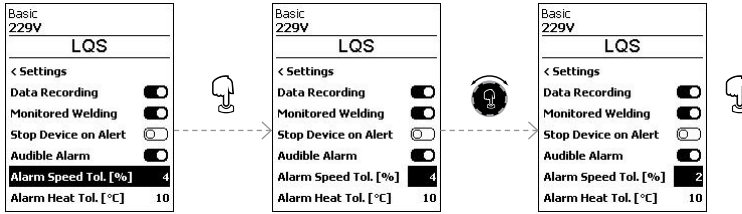

Seam Naming

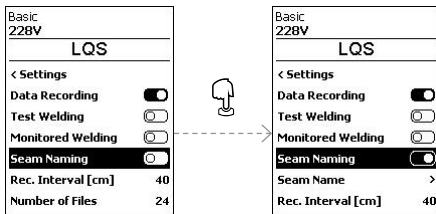

Seam Name

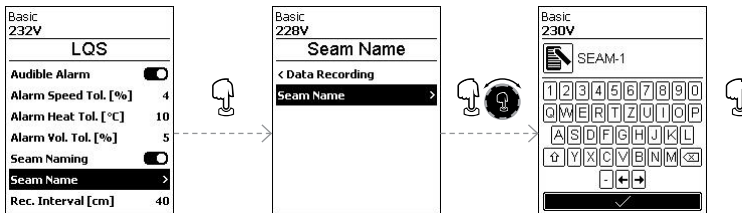

Rec. Interval

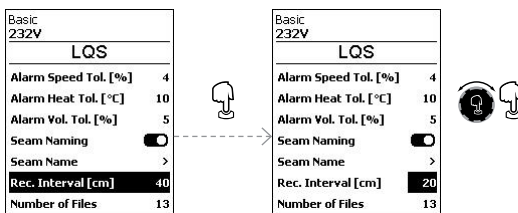

Number of Files

Basic	234V
LQS	
Alarm Heat Tol. [°C]	10
Alarm Vol. Tol. [%]	5
Seam Naming	<input checked="" type="checkbox"/>
Seam Name	>
Rec. Interval [cm]	20
Number of Files	13
Free Memory [MB]	7620

The number of recorded files is displayed.

Free memory

Basic	234V
LQS	
Alarm Vol. Tol. [%]	5
Seam Naming	<input checked="" type="checkbox"/>
Seam Name	>
Rec. Interval [cm]	20
Number of Files	13
Free Memory [MB]	7620
GPS	<input type="checkbox"/>

The free memory capacity is displayed.

GPS

Basic	229V
LQS	
Seam Naming	<input checked="" type="checkbox"/>
Seam Name	>
Rec. Interval [cm]	20
Number of Files	1
Free Memory [MB]	7621
GPS	<input type="checkbox"/>
GPS Position	>



Basic	229V
LQS	
Seam Naming	<input checked="" type="checkbox"/>
Seam Name	>
Rec. Interval [cm]	20
Number of Files	1
Free Memory [MB]	7621
GPS	<input type="checkbox"/>
GPS Position	>

GPS is switched off at the factory.

The GPS coordinates of the welds are displayed in the welding protocol.

GPS Position

Basic	229V
LQS	
Seam Naming	<input checked="" type="checkbox"/>
Seam Name	>
Rec. Interval [cm]	20
Number of Files	1
Free Memory [MB]	7621
GPS	<input type="checkbox"/>
GPS Position	>



Basic	235V
GPS Position	
N 46° 54.8271'	
Longitude	
E 8° 15.5502'	
Elevation	
468.19 m	
Satellites in view	10
HDOP	1.91



Now you can view the GPS position data if there is a connection to the satellite.

The symbol for GPS reception is displayed in the status display (40). If the symbol is solid black, satellites were found. If the symbol is not filled in, satellites are being searched for.

9.7 Advanced mode settings

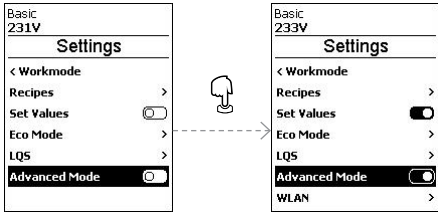

If you have activated Advanced Mode, additional menu options are available to you.

9.8 WLAN settings

WLAN is switched off at the factory.

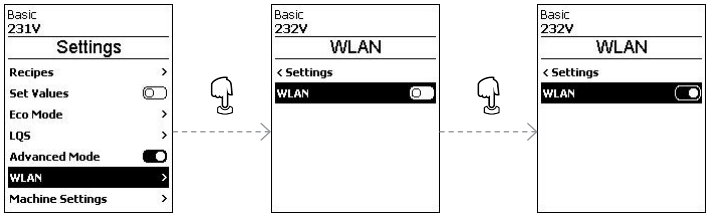

9.9 Device settings

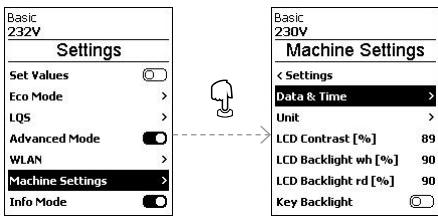

Date and time setting

Here you can set the hour, minute, year, month and day.

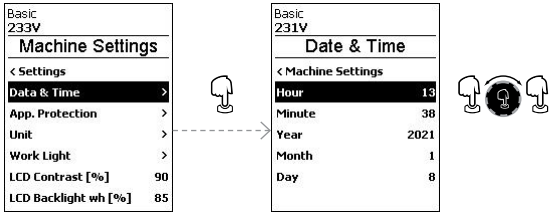

Unit

Here you can select the unit of the display; metric or imperial.

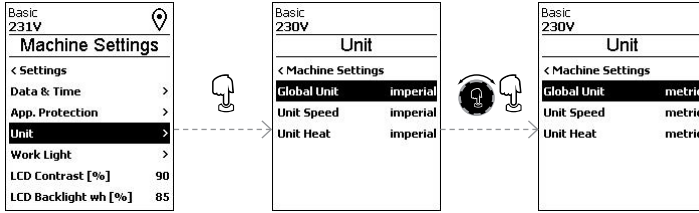

LCD Contrast

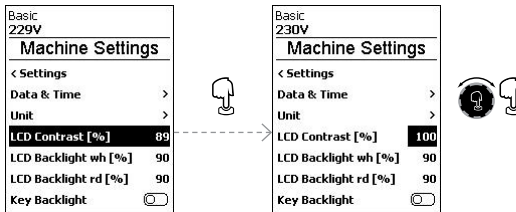

LCD Backlight (wh, rd)

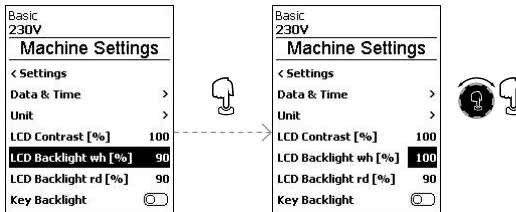

Backlight button

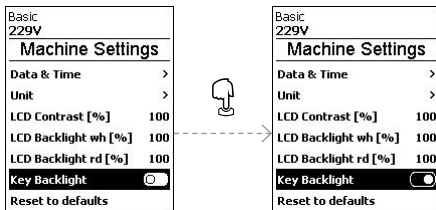

Using the [Button-Backlight](#) function you can switch the illumination of the buttonboard on or off.

Reset to defaults

Activating the Reset to defaults function resets all settings to factory default.

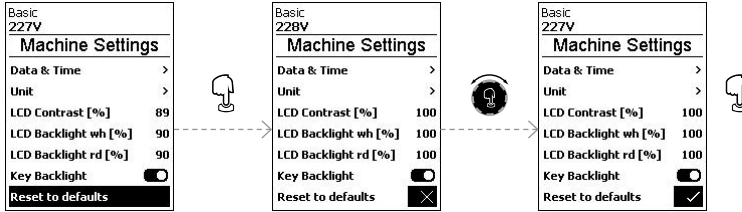

9.10 Info mode

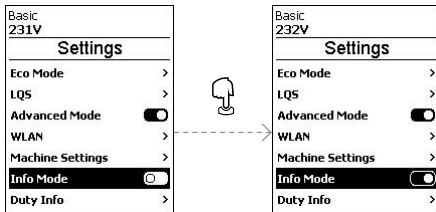

Info Mode is switched off at the factory.

If Info Mode is activated, additional information is displayed at the work level.

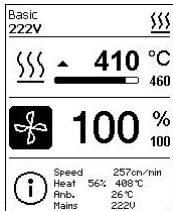

The following information is displayed:

- Speed in cm/min
- Capacity utilization of the heating output in percent as well as the temperature in °C
- Ambient temperature in °C
- Mains voltage in V

9.11 Duty info

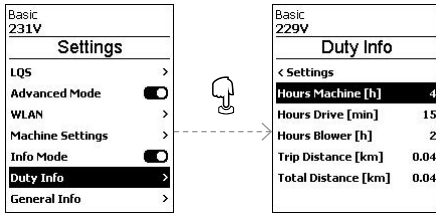

If **Duty Info** is activated, the runtimes of the machine, the drive and the blower are displayed. In the two lines below, you can see the distances traveled as a day counter and as total run time. The day counter can be deleted by you.

To delete the day counter, select the menu item **Trip Distance**.

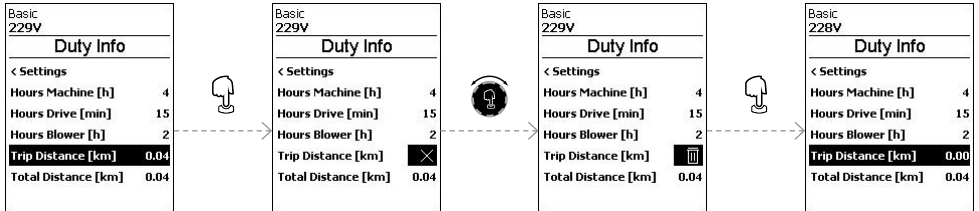

9.12 General Info

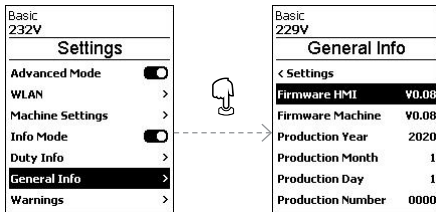

The following information is displayed:

- Software version HMI and PCU
- Production date of the machine
- Serial number

10. VARIMAT 700/500 warning and error messages

All warnings are displayed via the Warnings function.

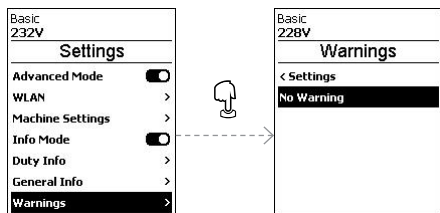



If there is a warning pending, you can still continue to work largely without restrictions.

In contrast to the warning message, it is **not possible to continue working once an error message has appeared**. The heating is switched off automatically and the drive is blocked. The display of the corresponding error codes takes proceeds without delay in the Work display (41).

You can receive specific information regarding the type of error or warning at any time, including via the menu Settings under Show Warnings.

Message type	Display	Error code	Description and measures
Warning		---	<p>Example warning symbol in the status display (33).</p> <p>Supply voltage too high. At the same time, the red backlight of the LCD module is switched on alternately.</p>
Error		0008	<p>Error symbol and text of note (Error No. 0008/Excessive temperature) in the work display Solution: Let the device cool down</p>
Error		0020	<p>Error symbol and text of note (Error No. 0020/Heating element defective) in the work display. Solution: Replace the heating element</p>

Error (including address of sales and service partner, if applicable)*	<div style="border: 1px solid black; padding: 5px;"> <p>Basic 162V</p>  <p>Error No.0002</p> </div>	0002	Undervoltage/overvoltage
		0004	Hardware error
		0008	Thermoelement is defective
		0100	Blower is faulty
		0200	Communication module error
	<div style="border: 1px solid black; padding: 5px;"> <p>Basic 232V</p>  <p>Error No.0100 Contact your service center</p> <p>www.leister.com</p> </div>	0400	Drive error
Service message	<div style="border: 1px solid black; padding: 5px;"> <p>Basic 230V</p>  <p>Maintenance Servicing</p> </div>	---	<p>When the device's service counter reaches 2500 operating hours, the message „Maintenance Servicing“ appears on the display the next time the main switch (20) is activated. This message is displayed for 10 seconds or can be skipped until the next switch-on by pressing the <i>e-Drive</i> button (33).</p>
Contact *Leister Sales and Service Partners			

11. VARIMAT 700/500 FAQs, causes and measures



The device switches on automatically after the blowers have been switched on:

- If the air temperature is higher than 100 °C when the device is switched on – which can occur, for example, if the device is disconnected from the power supply without the cooling process – the device automatically switches to cool-down mode. The cool-down process is finished when the air temperature is less than 100 °C for 2 minutes.

Unit switches off automatically:

- In Standby operation, the heating is switched off automatically after the time elapses that the user has stored (see also  Standby mode [9.5]).

Welding result of deficient quality:

- Check drive speed, welding temperature and air volume.
- **Clean the welding nozzle (11)** with a wire brush (see  Switching off the device/Maintenance [6.6])
- **Welding nozzle (11)** set incorrectly (see  Setting the welding nozzles [5.1])
- **Track guide roller (16)** incorrectly adjusted and causing undulation
- **Incorrect device operation**, contact salessupport@leister.com

After 5 minutes at the most, the set welding temperature has still not been reached:

- Check the supply voltage
- Reduce the air volume
- Check heating element

Device does not move forward in a straight line:

- **Align the track guide roller (16)** so that it is parallel and linear to the **drive/pressure roller (10)** (see  welding sequence [6.4]).
- Use the setting gauge for easy setting (included in the scope of delivery)
- **Set the transport roller (14)** with the **track setting (15)**, check the **track setting display (13)**.

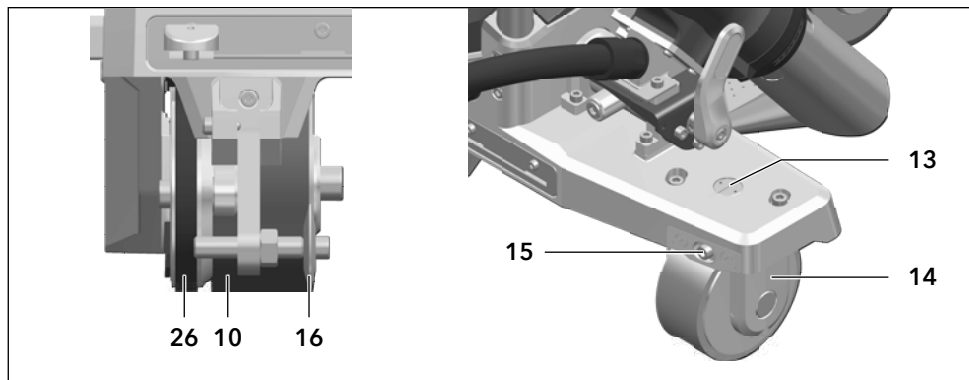

Continue to next page

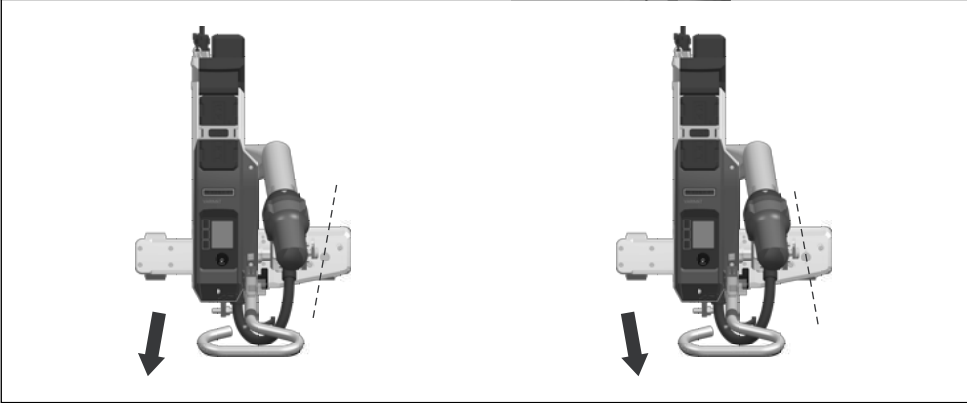
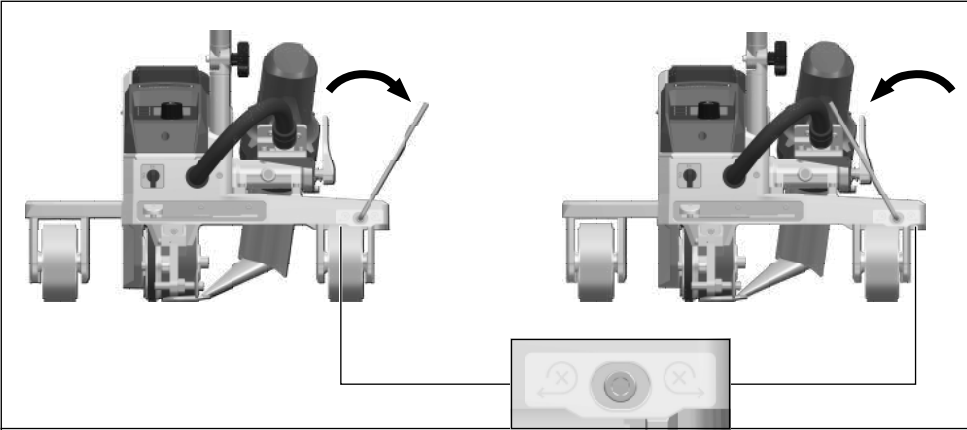

12. Operating VARIMAT 300

12.1 Starting the device

- Once you have prepared the working area and the hot air welder in accordance with the description, connect the hot air welder to the supply voltage.
- Use the **main switch (20)** to switch the hot-air welder on.



After connection, the start screen appears briefly on the display of the **operating unit (2)** with the **version number** of the current software release and the device designation.

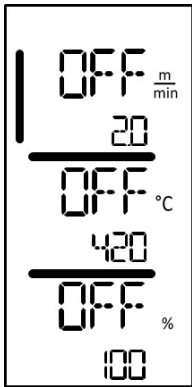

If the device was allowed to cool down beforehand, this will be followed by a static display of the set values for the most recently set welding parameters.

At this stage, the heating, blower and drive are switched off.

Now switch the heating on with the *heating On/Off* button (31).

12.2 Welding sequence

Preparing for welding

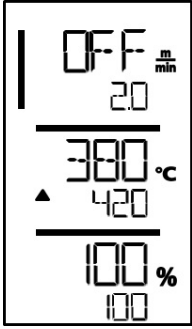

As soon as you have switched on the heating, you will see a dynamic display of the current air temperature (actual and set value). All welding parameters (welding speed, temperature and air volume) can be set.

- Make sure that the welding temperature has been reached before commencing work (LED stops flashing). The heat-up time is 3–5 minutes.
- Now carry out test welds in accordance with the welding instructions of the material manufacturer and/or national standards or regulations and inspect the results. Adjust the welding profile as required.

Start welding

- Press the **hot-air blower lock lever (12)**, lower the **hot-air blower (9)** and guide the **welding nozzle (11)** between the overlapping sheets up to the stop.
- The drive motor starts automatically as soon as the **hot-air blower (9)** is engaged.

Guiding the device during the welding process

- Guide the hot-air welder by the **guide bar (23, 25)** or by the **carrying handle (4)** along the overlap and also observe the position of the **track guide roller (16)**.
- Avoid applying pressure to the **guide bar (23, 25)** during the welding process, as doing so could lead to welding faults.

12.3 Finishing welding

- After finishing welding, press the **hot-air blowers lock (12)**, extend the **hot-air blowers (9)** up to the stop and swivel them upwards until they engage.
- Then swivel the **track guide roller (16)** upwards.

12.4 Switching off the device/Maintenance



Use the *Heating On/Off* button (31) to switch off the heating, so the **welding nozzle (11)** cools down.

This will trigger the cool-down mode.

- The blower switches off automatically after approx. 6 minutes.
- Now switch off the device with the **main switch (20)** and disconnect the **power cord (6)** from the electrical network.



- Wait until the device has cooled down.
- Check the **power cord (6)** and plug for electrical and/or mechanical damage.
- Use a wire brush to clean the **welding nozzle (11)**.

13. VARIMAT 300 quick guide



Observe the safety instructions and warnings in the individual sections of these operating instructions.





13.1 Switching on/Starting

1. Make sure that the **main switch (20)** is switched off and the **hot-air blowers (9)** are in parking position. Connect the plug to the mains voltage.
2. Switch the **main switch (20)** on.
3. Switch on the heating with the *heating On/Off (31)* button; wait 3–5 minutes until the desired temperature is reached.
4. Swivel the **hot-air blower (9)** downwards (appliance starts automatically).

13.2 Switching off

1. Swivel the **hot-air blower (9)** upwards (stops the drive motor).
2. Use the *heating On/Off (31)* button to switch off the **Heating**.
3. Wait for the end of the **cooling process** (approx. 6 minutes).
4. Switch off the unit at the **main switch (20)**.
5. Disconnect the **plug** from the mains voltage.



**VARIMAT 700 / 500 / 300**
Quick Guide





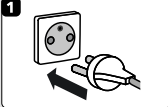

Operating Instructions:
leister.link/qg-dlp-varimat-700

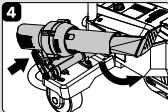
Download
myLeister App







1. 
2. **ON** 
3. 
4. 



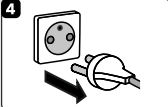

1. 
230V/400V
3. 
5 min



1. 
2. 
3. **OFF** 
4. 



2. 
4. 

QG VARIMAT 700/500/300 / 12.2023 / 175.792

14. VARIMAT 300 operating unit

14.1 Function buttons

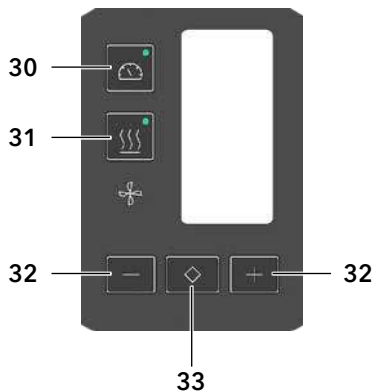

- 30. Button *Drive On/Off*
- 31. Button *Heating On/Off*
- 32. Buttons *Plus/Minus*
- 33. Button *Confirm*

Function buttons

Symbol	Name	Function
	Button <i>Motor On/Off</i> (30)	Switches drive on and off
	Button <i>Heating On/Off</i> (31)	Switches heating on and off
	Blower symbol	No function
 	Button <i>Minus/Plus</i> (32)	Setting the required set value in increments of 0.1m/min, 10 °C or 5 %
	Button <i>Confirm</i> (33)	Switches between the set values to be set

14.2 Digital display

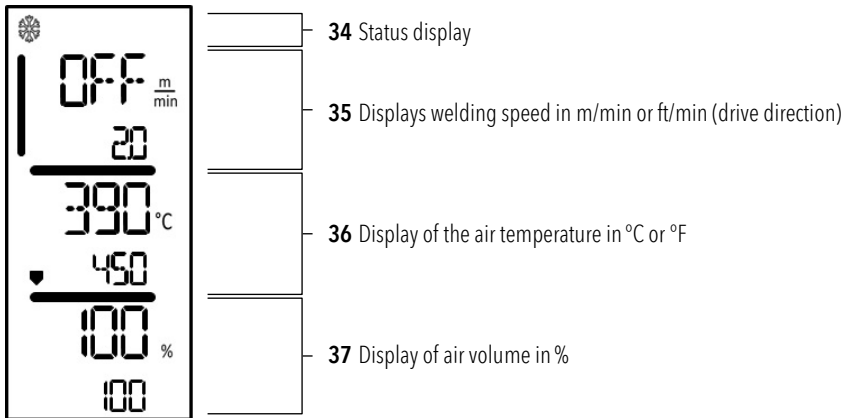





During operation, the set values of the welding parameters (drive in m/min or ft/min, temperature in degrees Celsius (°C) or Fahrenheit (°F)), air volume in percent (%) and, if applicable, information notes are displayed.

Use the *Confirm* button (33) to switch between the welding parameters and adjust the values individually with the *Minus/Plus arrow* (32) buttons.

14.3 Display symbols of the status display (Display 34)

Status display

	Symbol for cool-down mode
	Symbol for warning note, warning message or error message Let the device cool down (see also  Warning notes / Symbols for warning and error messages)
	Reference to service Symbol for hardware error warning The device is no longer ready for operation. Please contact your authorized Leister sales and service partner. (Note the respective error code in the Section  Warning and Error Messages).

14.4 Display symbols for the welding speed (Display 35)



Welding speed actual value and set value
The arrow in the display for the welding speed indicates the **drive direction**.

14.5 Display symbols for the welding temperature (Display 36)



- **Welding temperature too low, heating process**
The **up arrow** indicates that the desired **higher temperature** has not yet been reached. The flashing number designates the currently achieved actual value (430); the value below (450) shows the set value of the individual setting.



- **Welding temperature too high, cooling process**
The **down arrow** indicates that the desired **lower temperature** has not yet been achieved. The flashing value designates the currently achieved actual value (470); the value below (450) shows the set value of the individual setting.

14.6 Display symbols for the air volume (Display 37)



Actual and set value of the air volume

14.7 Status LED display

Heating

The LED on the *Heating On/Off* button (31) displays the condition of the heating.

LED status <i>Heating On/Off</i> (31)	Condition
LED off	Heating is switched off.
LED flashes green	Heating is switched on, temperature is outside tolerance
LED continuously green	Heating is switched on, temperature is within tolerance

Drive

The LED on the *Drive On/Off* (30) button displays the condition of the drive.

LED status <i>Drive On/Off</i> (30)	Condition
LED off	Drive is switched off
LED continuously green	Drive is switched on

Heating and drive

If both LEDs of the *Heating on/off* (31) and the *Drive on/off* button (30) are flashing simultaneously, there is an error (see  Error message [16]).

15. Settings and functions of the VARIMAT 300 software

15.1 Setting the parameter units

The units for the welding speed and for the temperature can be adjusted by you.

Temperature: °C or °F
Speed: $\frac{\text{m}}{\text{min}}$ or $\frac{\text{ft}}{\text{min}}$

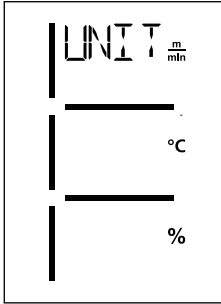

- Hold down the *Drive On/Off* (30) and *Heating On/Off* (31) buttons and connect the power cord to the power supply. „UNIT“ then appears on the display.
- Press the *Confirm* (33) button to confirm and use the *Plus/Minus* (32) buttons to set the desired units.
- Press the *Confirm* (33) button to confirm and use the *Plus/Minus* (32) buttons to select SAVE. Press the *Confirm* (33) button to confirm; the units are then saved.

The device then restarts automatically.

15.2 Setting the welding parameters

You can regulate the set values of the three welding parameters individually, even during operation. During operation, the selected range automatically switches to the row **welding speed (35)** after 5 seconds.

Proceed as follows:



Select:

Select the desired set value for drive, temperature or air with the *Confirm* (33) button.

Representation:

The selected area is indicated by a bar at the side

Setting:

Use the *Minus/Plus* buttons (32) to adjust the selected set value to match your requirements.

15.3 Cool-down mode

The heating is switched off during the cool down process. The set values cannot be changed during the cool down process.

If the air temperature is more than 60 °C when the device is switched on, the device switches automatically to Cool down mode.

The cool-down process is finished when the air temperature is less than 100 °C for 2 minutes.

If you want to switch the heating on again, you must press the *Heating „On/Off“* button (31).

15.4 Monitoring welding parameters during runtime

Welding speed, air temperature and air volume are monitored continuously.

If an actual value deviates from the set value according to the individual settings, this is indicated in the working display (see  Display symbols of welding temperature [14.5]).

16. VARIMAT 300 warning and error messages

Error messages are shown on the display of the **operating unit (1)**.

If an error message appears, you cannot continue working.

The heating is switched off automatically and the drive is blocked. The corresponding error codes are displayed immediately on the display of the **operating unit (2)**. The first four digits indicate the error group. The second four digits indicate the detailed error.

Example:

Error:

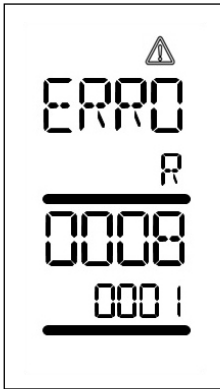

Warning:

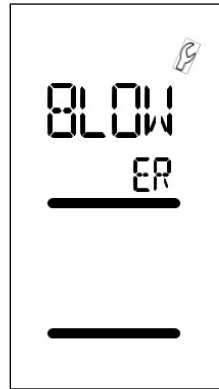



Error group	Description	Measures
0001	Electronics temperature measurement	Temperature >90 °C Let the device cool down
0004	Supply voltage	Connect the device to a different power socket If the error is still displayed, contact Leister Sales and Service Partners.
0008	Thermoelement/heating element	Contact Leister Sales and Service Partners
0100	Blower motor	Contact Leister Sales and Service Partners
0400	Drive motor	Contact Leister Sales and Service Partners
BLOWER	Carbon brushes for blower motor	Appears after 1400 operating hours The carbon brushes of the blower motor must be replaced.

17. Frequently asked questions, causes and actions VARIMAT 300

The device switches on automatically after the blowers have been switched on:

- If the air temperature is higher than 100 °C when the device is switched on – which can occur, for example, if the device is disconnected from the power supply without the cooling process – the device automatically switches to cool-down mode. The cool-down process is finished when the air temperature is less than 100 °C for 2 minutes.

Welding result of deficient quality:

- Check drive speed, welding temperature and air volume.
- **Clean the welding nozzle (11)** with a wire brush (see  Switching off the device/Maintenance [12.4])
- **Welding nozzle (11)** set incorrectly (see  Setting the welding nozzles [5.1])
- **Track guide roller (16)** incorrectly adjusted and causing undulation
- **Incorrect device operation**, contact salessupport@leister.com

After 5 minutes at the most, the set welding temperature has still not been reached:

- Check the supply voltage
- Reduce the air volume
- Check heating element

Device does not move forward in a straight line:

- **Align the track guide roller (16)** so that it is parallel and linear to the **drive/pressure roller (10)** (see  welding sequence [12.2]).
- Use the setting gauge for easy setting (included in the scope of delivery)
- **Set the transport roller (14)** with the **track setting (15)**, check the **track setting display (13)**.

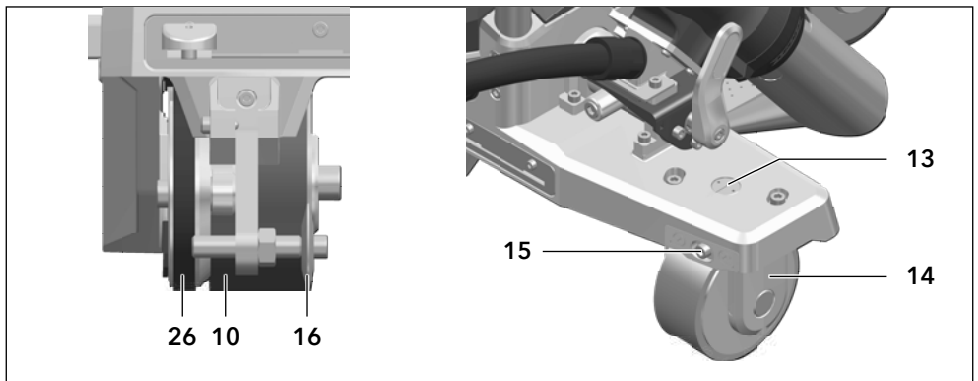

Continue to next page

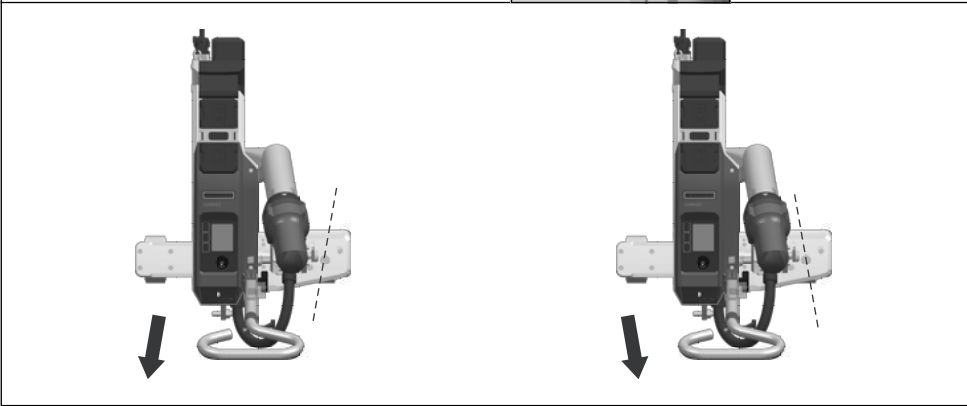
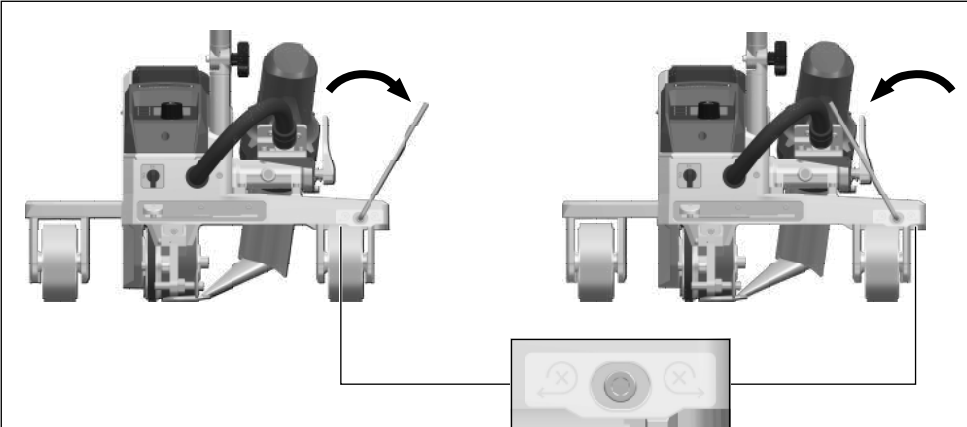

18. Accessories

For more information please visit leister.com.

19. Service and repair

Repairs shall be performed exclusively by authorized Leister sales and service partners. You will find the address of your authorized Leister sales and service partner on the last page of these operating instructions.

For more information please visit leister.com.

20. Training

The Leister Academy and its authorised Leister sales and service partners offer welding courses as well as product and application training.

For more information please visit leister.com.

21. Declaration of Conformity

EU Declaration of Conformity

Leister Technologies AG, Galileo-Strasse 10, 6056 Kaegiswil, Switzerland confirms that this product fulfills the requirements of the following EU Guidelines in the models that we have made available for purchase.

Directives: 2006/42/EC, 2014/30/EU, 2014/53/EU, 2011/65/EU

Harmonized standards: EN ISO 12100, EN 60335-1, EN 60335-2-45, EN 62233, EN 55014-1, EN 61000-6-2, EN 61000-3-2, EN 61000-3-3, ETSI EN 300 328, EN IEC 63000

Name of authorized representative for documentation: Thomas Schäfer, Manager Product Conformity

Kaegiswil, 11/30/2023

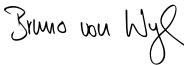

Bruno von Wyl, CTO



Pascal Bösch, VP R&D

UK Declaration of Conformity

Leister Technologies AG, Galileo-Strasse 10, 6056 Kaegiswil, Switzerland confirms that these products, in the versions as brought into circulation through us, fulfil the requirements of the following UK Statutory Instruments.

UK Statutory Instruments: 2008 No. 1597, 2016 No. 1091, 2017 No. 1206, 2012 No. 3032

Designated Standards: EN ISO 12100, EN 60335-1, EN 60335-2-45, EN 62233, EN 55014-1, EN 61000-6-2, EN 61000-3-2, EN 61000-3-3, ETSI EN 300 328, EN IEC 63000

Name of authorized representative for documentation: Thomas Schäfer, Manager Product Conformity

Kaegiswil, 11/30/2023

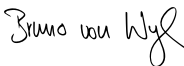

Bruno von Wyl, CTO



Pascal Bösch, VP R&D

22. Disposal



Do not dispose of electrical equipment with household refuse!

Electrical equipment, accessories and packaging should be recycled in an environmentally friendly manner. When you are disposing of our products, please observe the national and local regulations.

Warranty

- The guarantee or warranty rights granted for this device by the direct distribution partner/salesperson apply from the date of purchase. In the event of a guarantee or warranty claim (verification by invoice or delivery note), manufacturing or processing errors will be rectified by the sales partner through replacement delivery or repair. Heating elements are excluded from warranty obligations or guarantees.
- Other guarantee or warranty claims are excluded within the framework of mandatory law.
- Damage resulting from natural wear, overload, or improper handling is excluded from the warranty.
- Devices that have been converted or modified by the purchaser are not covered by any warranty or guarantee.
- Only use original Leister spare parts and accessories; otherwise, any warranty or guarantee claims will be invalidated.

↳ Sales and Service Partners



Leister Technologies AG

Galileo-Strasse 10

6056 Kaegiswil

Switzerland

+41 41 662 74 74

leister@leister.com

leister.com