

**LEISTER**®

English

# VACUUM PLATE 300

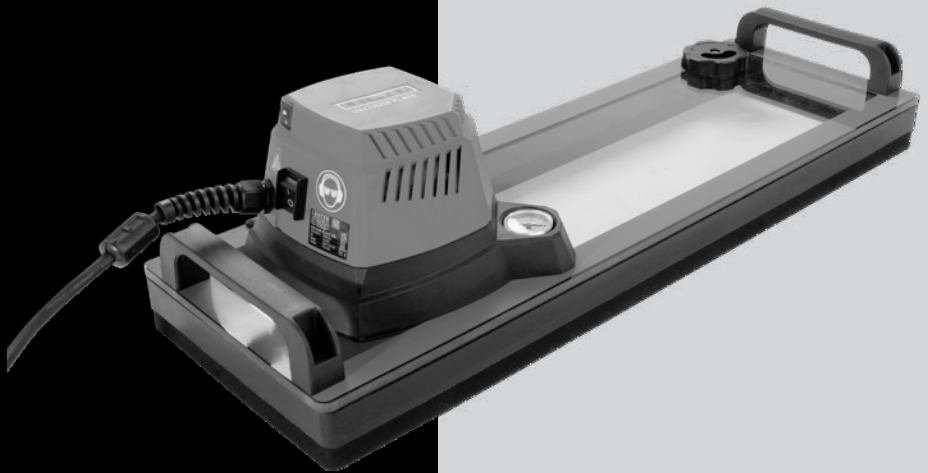

Leister Technologies AG  
Galileo-Strasse 10  
6056 Kaegiswil/Switzerland  
Tel. +41 41 662 74 74  
Fax +41 41 662 74 16  
[www.leister.com](http://www.leister.com)  
[sales@leister.com](mailto:sales@leister.com)

## Table of contents

<b>1. Important safety instructions</b>	<b>3</b>
<b>2. Application</b>	<b>4</b>
2.1. Intended use	4
2.2. Non-intended use	4
<b>3. Technical data</b>	<b>5</b>
<b>4. Transport</b>	<b>6</b>
<b>5. Your VACUUM PLATE 300</b>	<b>7</b>
5.1. Type plate and identification	7
5.2. Scope of delivery (Standard equipment in cardboard box)	7
5.3. Overview of device parts	8
<b>6. Operation of your VACUUM PLATE 300</b>	<b>9</b>
6.1. Work environment and safety	9
6.2. Preparation and operation	11
6.3. Test with VACUUM PLATE	11
<b>7. Quick guide VACUUM PLATE 300</b>	<b>12</b>
7.1. Switch on device (left column)	12
7.2. Switch off device (right column)	12
<b>8. Frequently asked questions, causes and actions VACUUM PLATE 300</b>	<b>13</b>
<b>9. Maintenance</b>	<b>14</b>
<b>10. Declaration of Conformity</b>	<b>15</b>
<b>11. Disposal</b>	<b>15</b>

## Congratulations on purchasing your VACUUM PLATE 300

You have chosen a first-class vacuum testing device.

It was developed and produced in accordance with the latest technology in the plastics-processing industry. It has also been manufactured using high-quality materials.



Please always store these operating instructions with the device.

## VACUUM PLATE 300 testing device



You can find more information about the VACUUM PLATE 300 at [www.leister.com](http://www.leister.com)

### 1. Important safety instructions

#### Warning



**Dangerous voltage, danger to life from electric shock:**

There are **live components inside the device**. Maintenance and repairs are to be carried out by trained specialist personnel only. **If the housing is damaged**, the power cord must be disconnected from the **power source immediately**. **Keep the device away from moisture and wet conditions**. Before starting, **check the power cord, the plug** and the extension cable for electrical and mechanical **damage**.



**Fire and explosion hazard**

Admixtures (e.g. combustible or explosive gases or vapors), traces of oil, oil vapor and grease must not be sucked in. Any **operation in a potentially explosive environment is prohibited**. The device must **only be operated with the filter plate installed**.



**No hazardous leak tracer is to be used for testing the weld seams**. There is a **risk of inhalation** of liquid particles. Read the material safety data sheet from the manufacturer of the material and follow that company's instructions.



**Risk of injury from plastic chips** at startup.

**Damaged plastic glass** can lead to **implosion**. This may cause eye injuries. The plastic glass must be protected against mechanical damage by impact or fall, for example. Do not put a defective VACUUM PLATE into operation. **Wear protective goggles**.



**Vacuum blower** causes **high noise levels**. There is therefore a **risk of hearing damage** while operating the device. **Wear hearing protection**.



**Risk of inhalation of dust particles** while operating the device. If the membrane is contaminated, dust particles can be sucked in and ejected by the blower. The **membrane** must be **free of impurities in the test area**.



If the device is being used on construction sites, a **fault current circuit breaker** must be used to protect site personnel from electrical shock **due to dampness and moisture**.

## Caution



### Risk of burns

The device may only be operated at intervals. If the on duration is too long (>2min), the temperature on the motor housing can cause burns. **Always allow the device** to cool down. The device can only be operated using the handles and switches provided. The main switch must be switched off in the event of a mains voltage failure.



The device should only be operated by **trained specialists** or under their supervision. Children are not permitted to operate the device.



Be aware of hazards in the surrounding area, e.g., risk of tripping, risk of slipping, strong sunlight, unattended equipment, etc.

## Note



The local supply **voltage** must match the nominal **voltage** specified on the device. **Incorrect mains voltage** can cause the device to fail. The main switch must be switched off in the event of a mains voltage failure.

## 2. Application

### 2.1 Intended use

The VACUUM PLATE 300 is intended for professional use and is used to check the weld seams for leaks.

The VACUUM PLATE 300 is intended for generating a vacuum in interval operation for max. 2 minutes ON/30 seconds OFF.

### Material types and material thicknesses







The VACUUM PLATE 300 can be used for testing various material types such as PE-HD, PE-LD, TPO/FPO, PP and PVC. The permissible material thicknesses of the indicated materials are 1 – 3 mm.

Use only original Leister spare parts and accessories; otherwise, any warranty or guarantee claims will be invalidated.

### 2.2 Non-intended use

Any other use or any use beyond the type of use described for the VACUUM PLATE 300 is deemed non-intended use. Test operation is not permitted in case of condensation (e.g. rain).

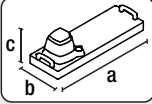
### 3. Technical data

			VACUUM PLATE 300 220 – 240 V	VACUUM PLATE 300 120 V
	Voltage	V~	230	120
	Power	W	1100	1100
	Frequency	Hz	50/60	
	Ambient temperature	°C	-10 – 60	
		°F	14 – 140	
	Noise level LA	L <sub>PA</sub> (dB)	84.7 (K = 3 dB)	
		L <sub>WA</sub> (dB)	95.7 (K = 3 dB)	
	Test pressure	bar	-0.170	
		inHg	-5	
	Weight	kg	7.7	
		lbs	17	
	Dimensions	a) mm	750	
		inches	29.5	
		b) mm	250	
		inches	9.8	
		c) mm	200	
		inches	7.9	
Accuracy class Manometer			1.6	
			 	

Subject to change without prior notice.

## 4. Transport

### Warning



Do not use the **carrying handle (8)** on the device for transporting with a crane.

### Note



When transporting the device, store and secure it in a way that prevents any mechanical damage. The device must always be stored on a flat surface, otherwise the **sealing lip (7)** can become permanently deformed.

Use the **carrying handles (8)** to lift the vacuum tester.



## 5. Your VACUUM PLATE 300

### 5.1. Type plate and identification

The model and serial number are indicated on your device's **name plate (10)**. Please transfer this information to your instruction manual. In the event of any inquiries to our representatives or authorized Leister Service Centers, please always refer to this information.

Model:.....

Serial no.:.....

Example:



### 5.2. Scope of delivery (Standard equipment in cardboard box)

- 1 x VACUUM PLATE 300 device
- 1 x Original Quick Guide
- 1 x Safety instructions

### 5.3. Overview of device parts

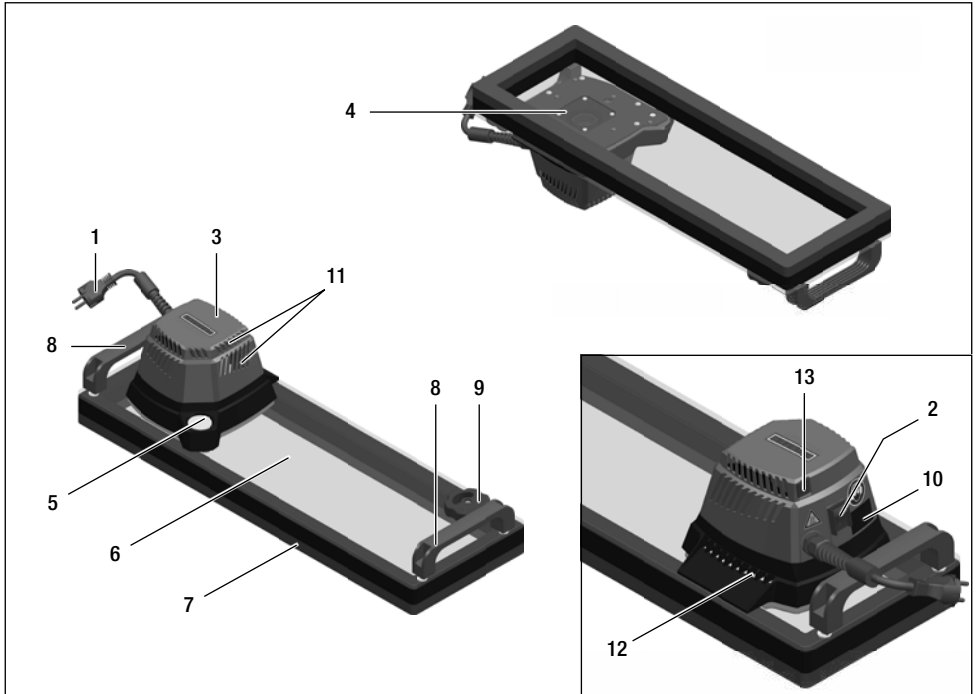

1. Mains connection line
2. Main switch
3. Vacuum blower
4. Filter plate
5. Pressure gauge
6. Sight glass
7. Sealing lip

8. Carrying handle
9. Pressure setting valve (Vari-Flow valve)
10. Type plate with model designation and series marking
11. Cooling openings
12. Suction air outlet
13. Device-protective circuit-breaker



## 6. Operation of your VACUUM PLATE 300

### 6.1. Work environment and safety

#### Warning



Dangerous voltage, danger to **life from electric shock**:

**If the housing is damaged**, the power cord must be disconnected from the **power source immediately**. **Keep the device away from moisture and wet conditions**. Before starting, **check the power cord, the plug** and the extension cable for electrical and mechanical **damage**.



**Fire and explosion hazard**

Admixtures (e.g. combustible or explosive gases or vapors), traces of oil, oil vapor and grease must not be sucked in. Any **operation in a potentially explosive environment is prohibited**. The device must **only be operated with the filter plate installed**.



**No hazardous leak tracer is to be used for testing the weld seams**. There is a **risk of inhalation of liquid particles**. Read the material safety data sheet from the manufacturer of the material and follow that company's instructions.



**Risk of injury from plastic chips** at startup.

**Damaged plastic glass** can lead to **implosion**. This may cause eye injuries. The plastic glass must be protected against mechanical damage by impact or fall, for example. Do not put a defective VACUUM PLATE into operation. **Wear protective goggles**.



**Vacuum blower** causes **high noise levels**. There is therefore a **risk of hearing damage** while operating the device. **Wear hearing protection**.



**Risk of inhalation of dust particles** while operating the device. If the membrane is contaminated, dust particles can be sucked in and ejected by the blower. The **membrane** must be **free of impurities in the test area**.



If the device is being used on construction sites, a **fault current circuit breaker** must be used to protect site personnel from electrical shock **due to dampness and moisture**.

## Caution



### Risk of burns

The device may only be operated at intervals. If the on duration is too long (>2min), the temperature on the motor housing can cause burns. **Always allow the device** to cool down. The device can only be operated using the handles and switches provided. The main switch must be switched off in the event of a mains voltage failure.



Be aware of hazards in the surrounding area, e.g., risk of tripping, risk of slipping, strong sunlight, unattended equipment, etc.

## Note



The local supply **voltage** must match the nominal **voltage** specified on the device. **Incorrect mains voltage** can cause the device to fail. The main switch must be switched off in the event of a mains voltage failure.

## Power cord and extension cable

- The **power cord (1)** must be able to move freely and must not hinder the user or third parties during work (trip hazard).
- The extension cables must be authorized for the utilization site (such as, outdoors) and be marked accordingly. Take the necessary minimum cross-section for extension cables into account as required.

230 V~	up to 50 m	<b>3 × 1.5 mm<sup>2</sup></b>
	up to 100 m	<b>3 × 2.5 mm<sup>2</sup></b>
120 V~	up to 50 m	<b>3 × 1.5 mm<sup>2</sup></b>
	up to 100 m	<b>3 × 2.5 mm<sup>2</sup></b>

## On-site generators for power supply

When using on-site generators as a power supply, please ensure that the generators are equipped with residual-current circuit breakers.

The formula "2 × nominal power of the devices used" applies to the nominal power of generators.

## 6.2. Preparation and operation

- Before each start, check the VACUUM PLATE for faults and damage, e.g. cracks, splits or scratches; a defective VACUUM PLATE can implode
- Visually inspect that the **filter plate (4)** is present and whether it is clean.
- **Check the power supply line and plug (1)** as well as the extension cable for electrical and mechanical damage.
- **Check the cooling air openings (11)** must be open at all times and air must be able to be suctioned and purged unhindered
- Ensure the **sealing lip (7)** is not damaged
- **Warning:** Excessive damage to the sealing lip (7) may prevent the required test pressure from being reached.
- Connect the VACUUM PLATE to the **nominal voltage**. The **nominal voltage** specified on the device must match the **supply voltage**.

## 6.3. Test with VACUUM PLATE

- The welding area must be dry and free of contamination. Dirt particles may compromise the test.
- The seam area to be inspected must be sprayed with a liquid forming bubbles (e.g. soapy water) directly before the inspection. The liquid must not damage the seam and the weld material.
- **Set the pressure setting valve (Vari-Flow Valve) (9)** to minimum pressure before the test. Turn counter-clockwise until stop (-).
- Position the VACUUM PLATE on the location to be tested
- Place the VACUUM PLATE so that the seam to be tested is approximately in the middle of the longitudinal axis of the testing device. For longer test sections, the VACUUM PLATE needs to be repositioned accordingly. When moving the VACUUM PLATE, the test areas must be overlapped.
- In order to generate a negative pressure, the VACUUM PLATE must be pressed lightly on the location to be tested with both **handles (8)**.
- **Turn on the main switch (2)** on the VACUUM PLATE
- Turn the **pressure setting valve (Vari-Flow Valve) (9)** clockwise (+) until the desired or specified test pressure is set.
- The existing negative pressure can be read on the **manometer (5)**.
- Visual inspection of the weld seam for leaks
- The seam is sealed if there are no bubbles in the test liquid.
- **Switch off the main switch (2)** of the VACUUM PLATE, let the device cool down
- Then disconnect the **power cord (1)** from the electrical mains.
- Mark and repair any leaks

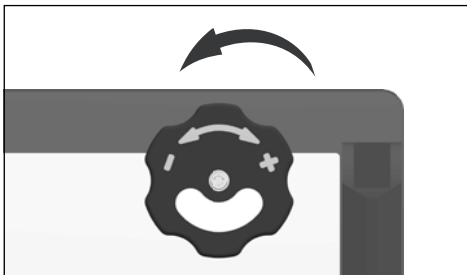

Turn anti-clockwise (-)  
pressure setting valve open/minimum pressure

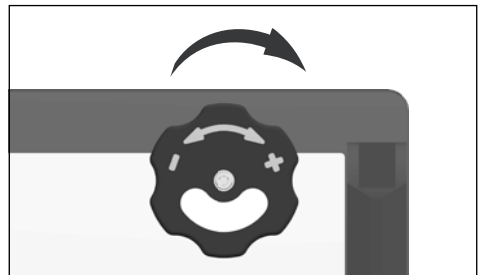

Turn clockwise (+)  
pressure setting valve closed/maximum pressure

## 7. Quick guide VACUUM PLATE 300

### 7.1. Switch on device (left column)

1. Connect **power supply cord (1)** to the voltage source.
2. **Open the pressure setting valve (Vari-Flow Valve) (9)** (turn counter-clockwise to the stop), hold the device by the **carrying handles (8)**, place it on the test location and gently press
4. Switch on the main **switch (2)**.
5. Set the pressure required with the **pressure setting valve (Vari-Flow Valve) (9)** (turn clockwise)

### 7.2. Switch off device (right column)

1. Switch off the device on the **main switch (2)**
2. Disconnect **the power cord (1)** from the voltage source

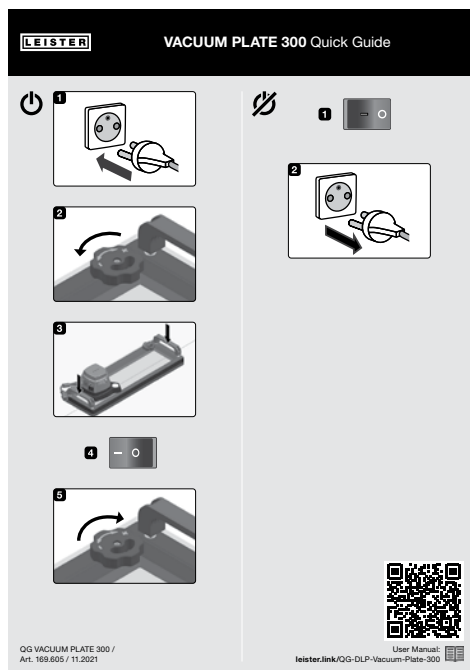

## 8. Frequently asked questions, causes and actions VACUUM PLATE 300

### Do not allow test pressure to build up

- Check the flatness of the membrane while pressing the VACUUM PLATE. The VACUUM PLATE can compensate an unevenness of approx. 10 mm via the **sealing lip (7)**. There is a risk of leakage if there is a higher level of unevenness.
- Check whether the **sealing lip (7)** is damaged. If the sealing lip is damaged, there is a risk of leakage.
- **Filter plate (4)** clogged. Clean the filter plate with a brush with plastic bristles.

### Diaphragm is touching the sight glass (6)

- Reduce the pressure with the **pressure adjustment valve (Vari-Flow Valve) (9)**.

### Device-protective circuit-breaker (13) trips during operation or does not lock into place (recognizable by protruding reset button)

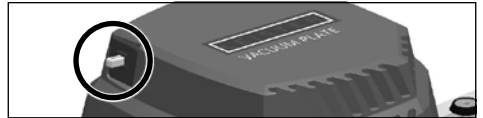

Causes	Action
Ambient temperature too high (> 60°C)	Allow the device to cool down. Then press the reset button on the device protection switch and repeat the process.
Defective vacuum motor	If the device circuit breaker switches the device off again immediately after resetting, the device must be inspected by an authorized Leister service center.
Excessive on-time	The appliance may only be operated at the prescribed intervals

## 9. Maintenance

### Warning



Dangerous voltage, danger to **life from electric shock**:

There are **live components inside the device**. Maintenance and repairs are to be carried out by trained specialist personnel only.

### Note



Avoid contact with **aggressive substances** (e.g. acetone, diluent, etc.). There is a **risk of damage** to the installed **components**.

- Repairs must only be carried out by authorized Leister service centers.
- Clean cloths must be used to clean the device.
- Leister Service Centers guarantee a professional and reliable repair service within 24 hours with original spare parts in accordance with circuit diagrams and spare parts lists.

You can find more information at [www.leister.com](http://www.leister.com)

### Recommended maintenance intervals for the device:

Period of time (operating hours)	Monitoring and maintenance work	Spare parts	Tools
After each use of the device	Visual inspection of the sealing lip for damage	–	Service
After each use of the device	Cleaning the sight glass	–	Water, clean cloth
After each use of the device	Visual inspection of the filter plate for contamination	–	Brush with plastic bristles
After each use of the device	Pressure adjustment valve moves freely	–	Service
after approx. 300 h	Functional check of the drive	Vacuum motor	Service

## 10. Declaration of Conformity

### EU Declaration of Conformity

**Leister Technologies AG, Galileo-Strasse 10, 6056 Kaegiswil, Switzerland** confirms that this product in the model made available for purchase, fulfills the requirements of the following EU directives.

Directives: 2006/42/EG, 2014/30/EU, 2011/65/EU

Harmonized EN ISO 12100:2010, EN 60335-1:2012 + A11:2014 + A13:2017 + AC:2014,

Standards: EN 55014-1:2017 + A11:2020, EN 55014-2:1997 + A1:2001 + A2:2008 + AC:1997,  
EN IEC 63000:2018

Kaegiswil, 02/24/2022

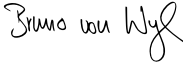

Bruno von Wyl, CTO



Christoph Baumgartner, GM

---

### UK Declaration of Conformity

**Leister Technologies AG, Galileo-Strasse 10, 6056 Kaegiswil, Switzerland** confirms that this product in the model made available for purchase, fulfills the requirements of the following UK Statutory Instruments.

UK Statutory

Instruments: 2008 No.1597, 2016 No. 1091, 2012 No. 3032

Designated EN ISO 12100:2010, EN 60335-1:2012 + A11:2014 + A13:2017 + AC:2014,

Standards: EN 55014-1:2017 + A11:2020, EN 55014-2:1997 + A1:2001 + A2:2008 + AC:1997,  
EN IEC 63000:2018

Kaegiswil, 02/24/2022

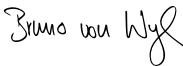

Bruno von Wyl, CTO



Christoph Baumgartner, GM

## 11. Disposal



### **Do not dispose of electrical equipment with household refuse.**

Electrical appliances, accessories and packaging should be recycled in an environmentally friendly manner. When you are disposing of our products, please observe the national and local regulations.



## Warranty

- The guarantee or warranty rights granted for this device by the direct distribution partner/salesperson apply from the date of purchase. In the event of a guarantee or warranty claim (verification by invoice or delivery note), manufacturing or processing errors will be rectified by the sales partner through replacement delivery or repair. Heating elements are excluded from warranty obligations or guarantees.
- Other guarantee or warranty claims are excluded within the framework of mandatory law.
- Damage resulting from natural wear, overload, or improper handling is excluded from the warranty.
- No guarantee or warranty claims exist for devices that have been converted or modified by the purchaser.

↳ Sales and service center

Leister Technologies AG  
Galileo-Strasse 10  
6056 Kaegiswil/Switzerland  
Tel. +41 41 662 74 74  
Fax +41 41 662 74 16  
[www.leister.com](http://www.leister.com)  
[sales@leister.com](mailto:sales@leister.com)